

7100 Anesthesia Ventilator Technical Reference Manual

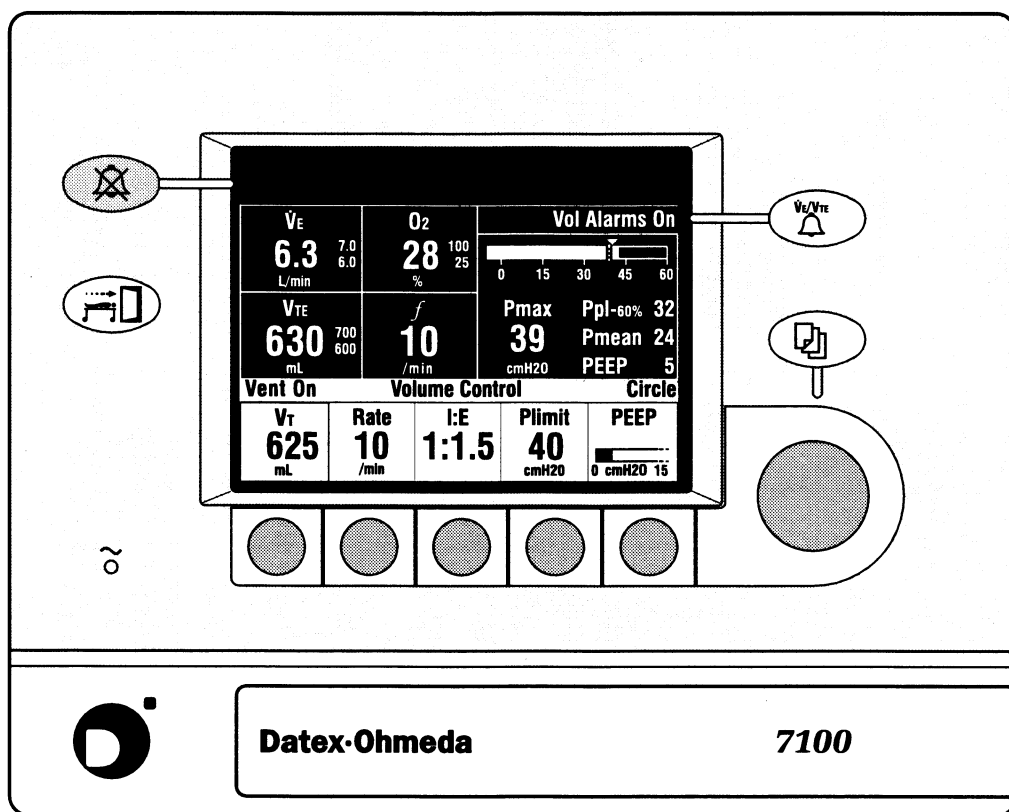

7100 Anesthesia Ventilator

Datex-Ohmeda products have unit serial numbers with coded logic which indicates a product group code, the year of manufacture and a sequential unit number for identification.

AAA F 12345

└───┬───┘
This alpha character indicates the year of product manufacture and when the serial number was assigned; "D" = 2000, "E" = 2001, "F" = 2002, etc. "I" and "O" are not used.



Aestiva and Aespire are registered trademarks of Datex-Ohmeda Inc.

Other brand names or product names used in this manual are trademarks or registered trademarks of their respective holders.

7100 Anesthesia Ventilator

used in

Aestiva and Aespire Anesthesia Machines

This document is not to be reproduced in any manner, nor are the contents to be disclosed to anyone, without the express authorization of the product service department, Datex-Ohmeda, Ohmeda Drive, PO Box 7550, Madison, Wisconsin, 53707.

© 2003 Datex-Ohmeda Inc.

Important

The information contained in this service manual pertains only to those models of products which are marketed by Datex-Ohmeda as of the effective date of this manual or the latest revision thereof. This service manual was prepared for exclusive use by Datex-Ohmeda service personnel in light of their training and experience as well as the availability to them of parts, proper tools and test equipment. Consequently, Datex-Ohmeda provides this service manual to its customers purely as a business convenience and for the customer's general information only without warranty of the results with respect to any application of such information. Furthermore, because of the wide variety of circumstances under which maintenance and repair activities may be performed and the unique nature of each individual's own experience, capacity, and qualifications, the fact that customer has received such information from Datex-Ohmeda does not imply in anyway that Datex-Ohmeda deems said individual to be qualified to perform any such maintenance or repair service. Moreover, it should not be assumed that every acceptable test and safety procedure or method, precaution, tool, equipment or device is referred to within, or that abnormal or unusual circumstances, may not warrant or suggest different or additional procedures or requirements.

This manual is subject to periodic review, update and revision. Customers are cautioned to obtain and consult the latest revision before undertaking any service of the equipment. Comments and suggestions on this manual are invited from our customers. Send your comments and suggestions to the Manager of Technical Communications, Datex-Ohmeda, Ohmeda Drive, PO Box 7550, Madison, Wisconsin 53707.

⚠ CAUTION Servicing of this product in accordance with this service manual should never be undertaken in the absence of proper tools, test equipment and the most recent revision to this service manual which is clearly and thoroughly understood.

Technical Competence

The procedures described in this service manual should be performed by trained and authorized personnel only. Maintenance should only be undertaken by competent individuals who have a general knowledge of and experience with devices of this nature. No repairs should ever be undertaken or attempted by anyone not having such qualifications.

Datex-Ohmeda strongly recommends using only genuine replacement parts, manufactured or sold by Datex-Ohmeda for all repair parts replacements.

Read completely through each step in every procedure before starting the procedure; any exceptions may result in a failure to properly and safely complete the attempted procedure.

Table of Contents

Important	ii
Technical Competence	ii

1 Introduction

1.1 What this manual includes	1-2
1.1.1 Software versions	1-2
1.2 Standard service procedures	1-3
1.2.1 User's reference manuals	1-3
1.2.2 Technical reference manuals	1-3
1.2.3 Ventilator tests	1-3
1.3 Symbols used in the manual or on the equipment	1-4

2 Theory of Operation

2.1 General Description	2-2
2.2 7100 ventilator features	2-4
2.2.1 Safety features	2-4
2.3 7100 ventilator components	2-5
2.3.1 Control Module	2-6
2.3.2 Monitoring interface	2-7
2.3.3 Serial interface	2-7
2.3.4 The Pneumatic Vent Engine	2-8
2.4 Electronic and electrical components	2-9
2.4.1 The Aestiva 7100 ventilator functional blocks	2-9
2.4.2 The Aespire 7100 ventilator functional blocks	2-10
2.4.3 Power Supply	2-11
2.4.4 Sealed Lead Acid Battery	2-11
2.4.5 Control Board	2-12
2.4.6 Monitoring interface	2-16
2.4.7 Serial interface	2-17
2.4.8 Pneumatic Vent Engine Board	2-18

2.5 Mechanical Subsystems	2-19
2.5.1 Supply Gas	2-19
2.5.2 Pressure Regulator	2-20
2.5.3 Inspiratory Valve	2-20
2.5.4 Exhalation (PEEP) Control	2-21
2.5.5 Bleed Resistor	2-22
2.5.6 Bellows Pressure Relief Valve	2-22
2.5.7 Mechanical Overpressure Valve	2-23
2.5.8 Free Breathing Valve	2-23
2.5.9 Breathing Circuit Flow Sensors	2-24

3 Post-Service Checkout

3.1 Post-service checkout	3-2
3.1.1 Test the 7100 ventilator	3-2
3.1.2 Test the anesthesia machine	3-2

4 Tests and Calibration

4.1 Self tests	4-2
4.2 Service Mode	4-3
4.3 About Ventilator	4-4
4.4 Alarm Log	4-5
4.5 Error Log	4-6
4.6 Language	4-7
4.7 User Settings	4-8
4.7.1 Screen Contrast	4-8
4.8 System Configuration	4-9
4.9 Calibrations	4-11
4.9.1 O2 Calibrations	4-12
4.9.2 Zero Flow and Airway Sensors	4-13
4.9.3 Adjust Drive Gas Regulator	4-14
4.9.4 Airway Sensor Span	4-15
4.9.5 PEEP Valve Calibration	4-17
4.9.6 Inspiratory Valve Calibration	4-18
4.9.7 Pressure Sensitivity	4-20
4.9.8 Service Calibrations Required	4-22

4.10 Diagnostic Tests/Tools 4-23

 4.10.1 Display A/D Channels 4-24

 4.10.2 Display Discrete I/O Signals 4-26

 4.10.3 Display Battery Status 4-27

 4.10.4 Test Panel Switches 4-28

 4.10.5 Valves - Test Tool 4-29

 4.10.6 Test CPU and Memory 4-30

 4.10.7 Test EEPROM 4-31

 4.10.8 Test Serial Port 4-32

 4.10.9 Test 5V Fail Alarm 4-33

 4.10.10 Test Inspiratory Valve 4-34

 4.10.11 Test PEEP Valve 4-35

 4.10.12 Test PEEP Safety Valve 4-36

 4.10.13 Breathing System Leak Test 4-37

 4.10.14 Test Pressure Limit Circuit 4-38

4.11 Upgrade Options 4-40

5 Troubleshooting

5.1 Troubleshooting instructions 5-2

5.2 Troubleshooting guide 5-2

5.3 Alarm and Error messages 5-4

5.4 Troubleshooting Flowcharts 5-15

 5.4.1 Ventilator assessment process 5-15

 5.4.2 No display troubleshooting 5-16

 5.4.3 Inaccurate volume ventilation troubleshooting 5-17

 5.4.5.B VMB board evaluation (Aespire machine) 5-19

 5.4.6 No ventilation troubleshooting 5-20

 5.4.7 High intrinsic PEEP troubleshooting 5-21

6 Maintenance

6.1 Maintenance Schedule 6-2

6.2 Free breathing valve maintenance 6-3

6.3 MOPV pressure relief valve test 6-4

 6.3.1 Test setup 6-4

 6.3.2 Test procedure 6-4

7 Repair Procedures

7.1 Software Installation	7-2
7.1.1 After replacing the Control Board or the Control Module	7-3
7.2 Control Module	7-4
7.2.1 Inside the control module	7-5
7.2.2 Control board	7-6
7.2.3 Battery and power supply	7-7
7.2.4 Front enclosure with control board removed	7-8
7.2.5 Front enclosure components	7-9
7.3 Pneumatic engine	7-11
7.3.1 Pneumatic Engine in an Aestiva machine	7-11
7.3.2 Pneumatic Vent Engine in an Aespire machine	7-12
7.3.3 Pneumatic engine components (Aespire machine)	7-13
7.3.4 Pneumatic engine components (Aestiva machine)	7-14
7.3.5 Supply gas inlet filter (Aestiva machine)	7-15
7.3.6 Insp/PEEP interface assembly and reservoir	7-16
7.3.7 Manifold and plate assembly	7-17
7.3.8 Pneumatic Engine Board and housing (Aestiva machine)	7-18
7.4 Monitoring Interface Assembly (MIA) in an Aestiva machine	7-19
7.5 Serial Adapter Board (SAB) and Power Cord/Harness	7-20

8 Illustrated Parts

8.1 Special instructions	8-2
8.2 Service tools	8-2
8.3 7100 Ventilator parts	8-3

9 Schematics and Diagrams

1 Introduction

In this section	1.1 What this manual includes	1-2	
	1.1.1 Software versions	1-2	
	1.2 Standard service procedures	1-3	
	1.2.1 User's reference manuals	1-3	
	1.2.2 Technical reference manuals	1-3	
	1.2.3 Ventilator tests	1-3	
	1.3 Symbols used in the manual or on the equipment	1-4	

1.1 What this manual includes

This manual covers the service information for the 7100 anesthesia ventilator which is an integral component in the Aestiva/5 7100 anesthesia machine and the S/5 Aespire anesthesia.

The Aestiva and the Aespire anesthesia machines have their own respective Technical Reference Manuals (TRM).

- Aestiva machine TRM: Stock Number 1006-0452-000
- Aespire machine TRM: Stock Number 1009-0356-000

Special notice

Some information in this manual can possibly point the reader to electronic troubleshooting and component/repair replacement level of service. This information, when supplied, is only supplied to add clarity to service or troubleshooting statements. Datex-Ohmeda Service Personnel are mandated by Company Policy to service electronic equipment to a board replacement level only.

- Read completely through each step in every procedure before starting the procedure; any exceptions can result in a failure to properly and safely complete the attempted procedure.
- Unless otherwise specified, values in this manual are nominal.
- Sections in this manual begin on odd numbered or right-hand pages. If there is no text on the preceding, backup even numbered page, it is labeled "Notes" for your use if you wish.
- Figures that require more than one page have the title and main text on the left (even numbered) page. Additional figure information is on the facing (odd numbered) page.

1.1.1 Software versions

The revision level is displayed on the ventilator start-up menu. This manual includes test and calibration procedures for Revision 1.X software.

1.2 Standard service procedures

1.2.1 User's reference manuals

Operation and maintenance procedures for the 7100 ventilator are covered in the User's Reference Manuals (URM) for the respective anesthesia machine. You must have, and be familiar with, the URMs for this product. Study the Aestiva or the Aespire URMs if you need further information about the operation of the system.

1.2.2 Technical reference manuals

You must first determine where a problem is located before you can determine which service manual to use:

- Use this manual for Ventilator related problems.
- Use the Aestiva machine TRM (1006-0452-000) or the Aespire machine TRM (1009-0356-000) for all other components of the respective anesthesia machine.

1.2.3 Ventilator tests

Service calibration functions let Datex-Ohmeda trained users and Datex-Ohmeda service personnel perform ventilator setup functions, tests, calibration and measurements from the front panel display.

Normal operational tests, calibration, and troubleshooting can be performed on your 7100 ventilator without removing components from the system. Repair may require removing the ventilator components from the anesthesia machine.

⚠ WARNING

Section 4, "*Service Mode Tests and Calibration*" must be performed whenever you access any internal component of the ventilator to verify that all critical parts of the ventilator are still operational and within specification.



⚠ WARNING

After the ventilator has been serviced, you must perform "*Post-Service Checkout*" to verify the entire anesthesia system is properly functioning before the system can be returned to clinical use.

⚠ WARNING

Do not perform testing or maintenance on this instrument while it is being used to ventilate a patient, possible injury may result.























1.3 Symbols used in the manual or on the equipment







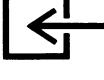

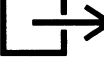













 Warnings and  Cautions tell you about dangerous conditions that can occur if you do not follow all instructions in this manual.

Warnings tell about a condition that can cause injury to the operator or the patient.

Cautions tell about a condition that can cause damage to the equipment. Read and follow all warnings and cautions.

Other symbols replace words on the equipment or in Datex-Ohmeda manuals. No one device or manual uses all of the symbols. These symbols include:

	On (power)		Alarm silence button
	Off (power)		Alarm silence touch key (Tec 6).
	Standby		Type B equipment
	Standby or preparatory state for part of the equipment		Type BF equipment
	“ON” only for part of the equipment		Type CF equipment
	“OFF” only for part of the equipment		Caution, ISO 7000-0434
	Direct current		Attention, refer to product instructions, IEC 601-1
	Alternating current		Dangerous voltage
	Protective earth ground		Electrical input
	Earth ground		Electrical output
	Frame or chassis ground		Pneumatic input
	Equipotential		Pneumatic output

+	Plus, positive polarity		Movement in one direction
-	Minus, negative polarity		Movement in two directions
	Variability		Read top of float
	Variability in steps		Vacuum inlet
	This way up		Suction bottle outlet
	Lamp, lighting, illumination		Cylinder
	Lock		Isolation transformer
	Unlock		Linkage system
	Close drain		Risk of Explosion.
	Open drain (remove liquid)		Low pressure leak test
134°C	Autoclavable		Mechanical ventilation
	Not autoclavable		Bag position/ manual ventilation
	Inspiratory flow		Expiratory flow
O₂%	O ₂ sensor connection	O₂+	O ₂ Flush button
REF	Stock Number	SN	Serial Number

7100 Anesthesia Ventilator



Alarm silence touch key



Volume alarms On/Off touch key



End case touch key



Menu touch key



Circle breathing circuit module

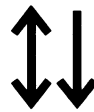

Bain/Mapleson D breathing circuit module



The primary regulator is set to pressure less than 345 kPa (50 psi)



The primary regulator is set to pressure less than 414 kPa (60 psi)



Absorber on



CO₂ Bypass Option



Absorber off (CO₂ Bypass active)



Systems with this mark agree with the European Council Directive (93/42/EEC) for Medical Devices when they are used as specified in their Operation and Maintenance Manuals. The xxx is the certification number of the Notified Body used by Datex-Ohmeda's Quality Systems.

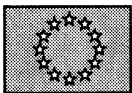

CE European Union Representative

2 Theory of Operation

In this section

This section includes functional descriptions and theory of operation for the major components of the 7100 ventilator.

2.1 General Description	2-2
2.2 7100 ventilator features	2-4
2.2.1 Safety features	2-4
2.3 7100 ventilator components	2-5
2.3.1 Control Module	2-6
2.3.2 Monitoring interface	2-7
2.3.3 Serial interface	2-7
2.3.4 The Pneumatic Vent Engine	2-8
2.4 Electronic and electrical components	2-9
2.4.1 The Aestiva 7100 ventilator functional blocks	2-9
2.4.2 The Aespire 7100 ventilator functional blocks	2-10
2.4.3 Power Supply	2-11
2.4.4 Sealed Lead Acid Battery	2-11
2.4.5 Control Board	2-12
2.4.6 Monitoring interface	2-16
2.4.7 Serial interface	2-17
2.4.8 Pneumatic Vent Engine Board	2-18
2.5 Mechanical Subsystems	2-19
2.5.1 Supply Gas	2-19
2.5.2 Pressure Regulator	2-20
2.5.3 Inspiratory Valve	2-20
2.5.4 Exhalation (PEEP) Control	2-21
2.5.5 Bleed Resistor	2-22
2.5.6 Bellows Pressure Relief Valve	2-22
2.5.7 Mechanical Overpressure Valve	2-23
2.5.8 Free Breathing Valve	2-23
2.5.9 Breathing Circuit Flow Sensors	2-24

2.1 General Description

The 7100 ventilator is a microprocessor based, electronically-controlled, pneumatically-driven ventilator with a built-in monitoring system for inspired oxygen, airway pressure and exhaled volume. The ventilator is an integral component of the Aestiva/5 7100 anesthesia machine and the S/5 Aespire anesthesia machine.

Figure 2-1 includes a functional block diagram of the 7100 ventilator components as used in an Aestiva anesthesia machine.

Figure 2-2 includes a functional block diagram of the 7100 ventilator components as used in an Aespire anesthesia machine.

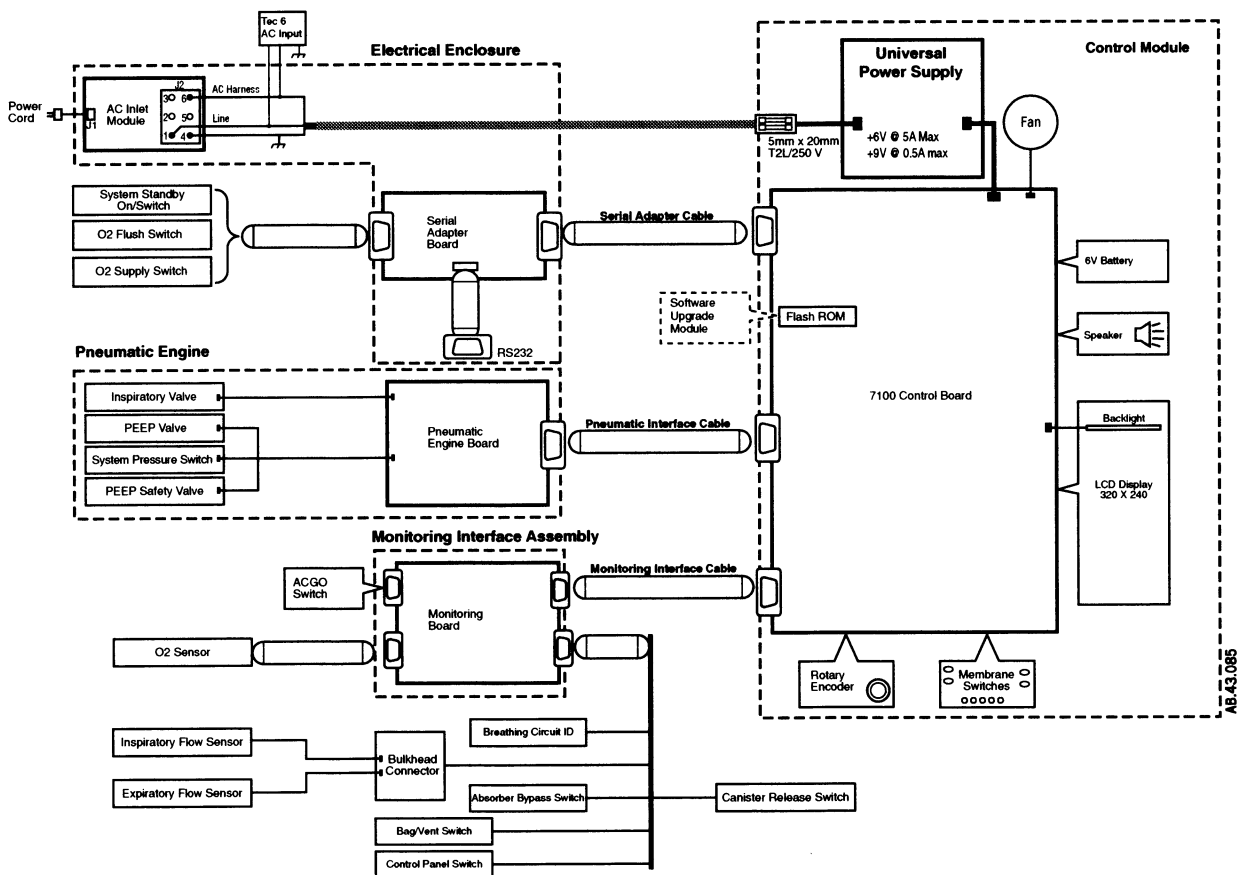

Figure 2-1 • 7100 ventilator functional block diagram as used in an Aestiva anesthesia machine

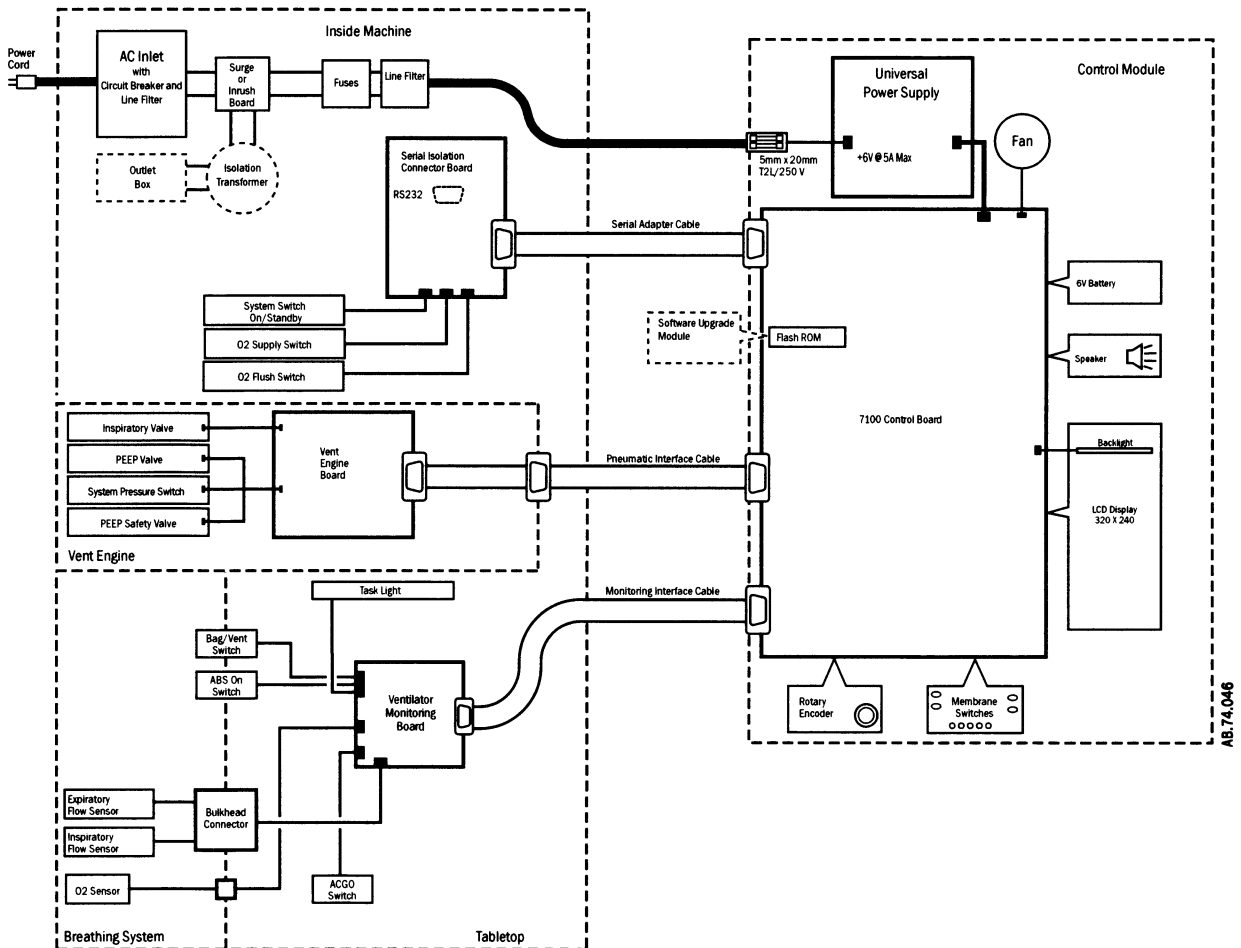

Figure 2-2 • 7100 ventilator functional block diagram as used in an Aespire anesthesia machine

2.2 7100 ventilator features

- Sensors in the breathing circuit are used to control and monitor patient ventilation and measure inspired oxygen concentration. This lets the ventilator compensate for compression losses, fresh gas contribution, valve and regulator drift and small leakages in the breathing absorber, bellows and system.
- Positive End Expiratory Pressure (PEEP) is generated electronically. PEEP is not active when mechanical ventilation is off.
- User settings and microprocessor calculations control breathing patterns. User interface settings are kept in non-volatile memory.
- Mechanical ventilation is started with the Bag/Vent switch on the breathing system.
- The 7100 ventilator reads the status of the Bag/Vent switch and the breathing circuit type (Circle, Bain — Aestiva only). The operator does not have to set the breathing circuit type from a menu.
- The 7100 ventilator has an operator-selectable Heliox mode (Aestiva only) to permit gas composition compensation when Heliox gas is used.
- The 7100 ventilator has minimum monitoring and alarms managed on the ventilator panel (there is no other panel for safety relevant alarm management, etc.).
- Ventilator hardware is regularly monitored by software tests.
- An RS-232 serial digital communications port connects to and communicates with external devices.
- An exhalation valve modulates flow in the pressure mode.
- Pressure and volume modes are selectable by the operator.
- All pneumatic components are located on one manifold.
- Exhausted drive gas and bellows pressure relief valve gases are mixed and go through the ventilator exhalation valve.
- The exhalation valve block is autoclavable.
- Excess fresh gas released from the bellows and ventilator drive gas are transferred from the exhalation valve to the Anesthesia Gas Scavenging System (AGSS).
- Optimized for service with a low number of components.

2.2.1 Safety features

- Dual redundant airway overpressure protection, linked to Plimit setting.
- Volume over-delivery limits and protection.
- Proprietary hose connections and fixed manifolds.
- Proven mechanical components used.
- 10 VA electrical power limiting to potential oxygen enriched environment.
- 150 psi burst overpressure protection.

2.3 7100 ventilator components

Major components of the 7100 ventilator are found in different locations of the anesthesia machine. These components, in general, serve identical functions in either machine; however, since some components have minor differences and are not interchangeable, they are named differently.

The ventilator package consists of:

1. a Control Module (CM) — which is identical for both machines.
The CM includes:
 - a Control Board (CB)
 - an LCD Display
 - a Keyboard (with rotary encoder switch)
 - a Power Supply
 - a backup battery
2. a Monitoring Interface Assembly (MIA) in an Aestiva machine or a Ventilator Monitoring Board (VMB) in an Aespire machine.
3. a Serial Adapter Board (SAB) in an Aestiva machine or a Serial Isolation Connector Board (SICB) in an Aespire machine.
4. a Pneumatic Engine (PE) with Pneumatic Engine Board (PEB) in an Aestiva machine or a Vent Engine (VE) with a Vent Engine Board (VEB) in an Aespire machine.

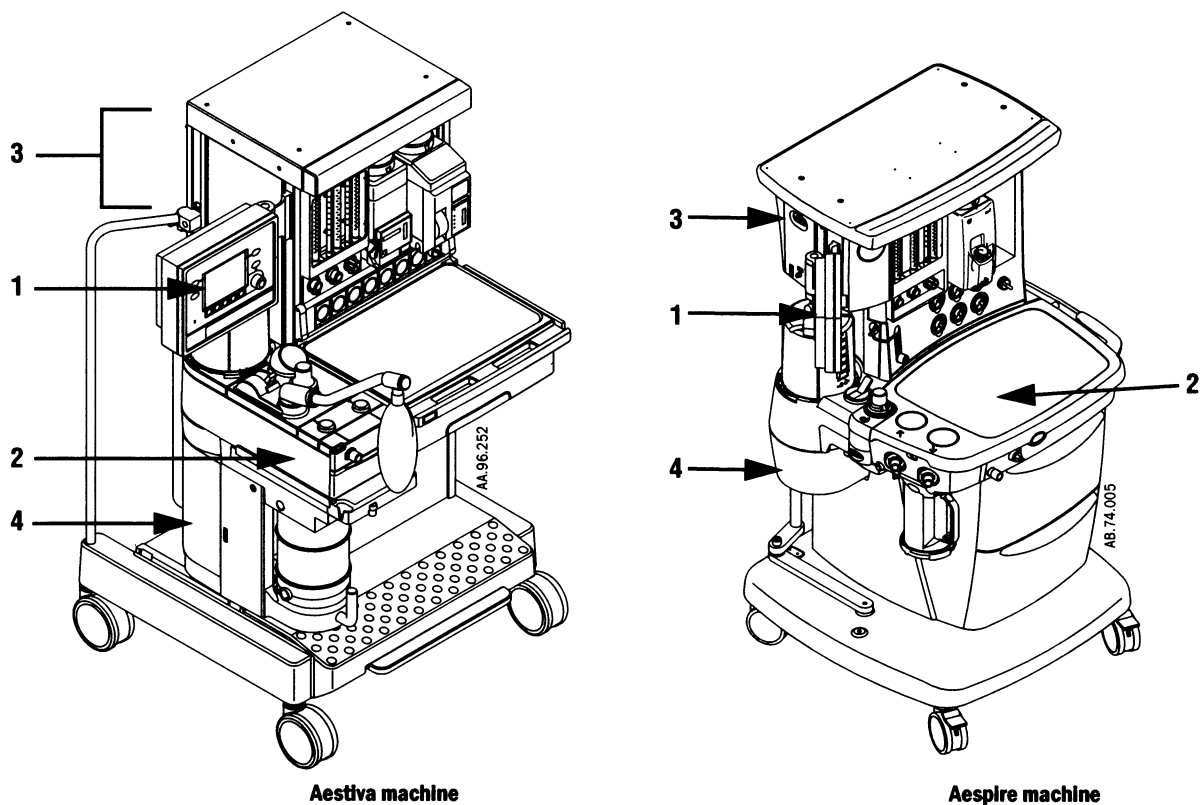

Figure 2-3 • Location of 7100 ventilator components

2.3.1 Control Module

The control module consists of two enclosures.

The rear enclosure includes:

1. inline fuses
2. a power supply
3. a cooling fan
4. a backup battery

The power supply receives AC power from the anesthesia machine. All the power necessary to operate the ventilator comes from the power supply.

The front enclosure includes:

5. a control board (controls operation of the ventilator)
6. a front panel assembly

The front panel assembly includes four submodules:

7. an LCD display
8. a keyboard front panel
9. a rotary encoder
10. a speaker

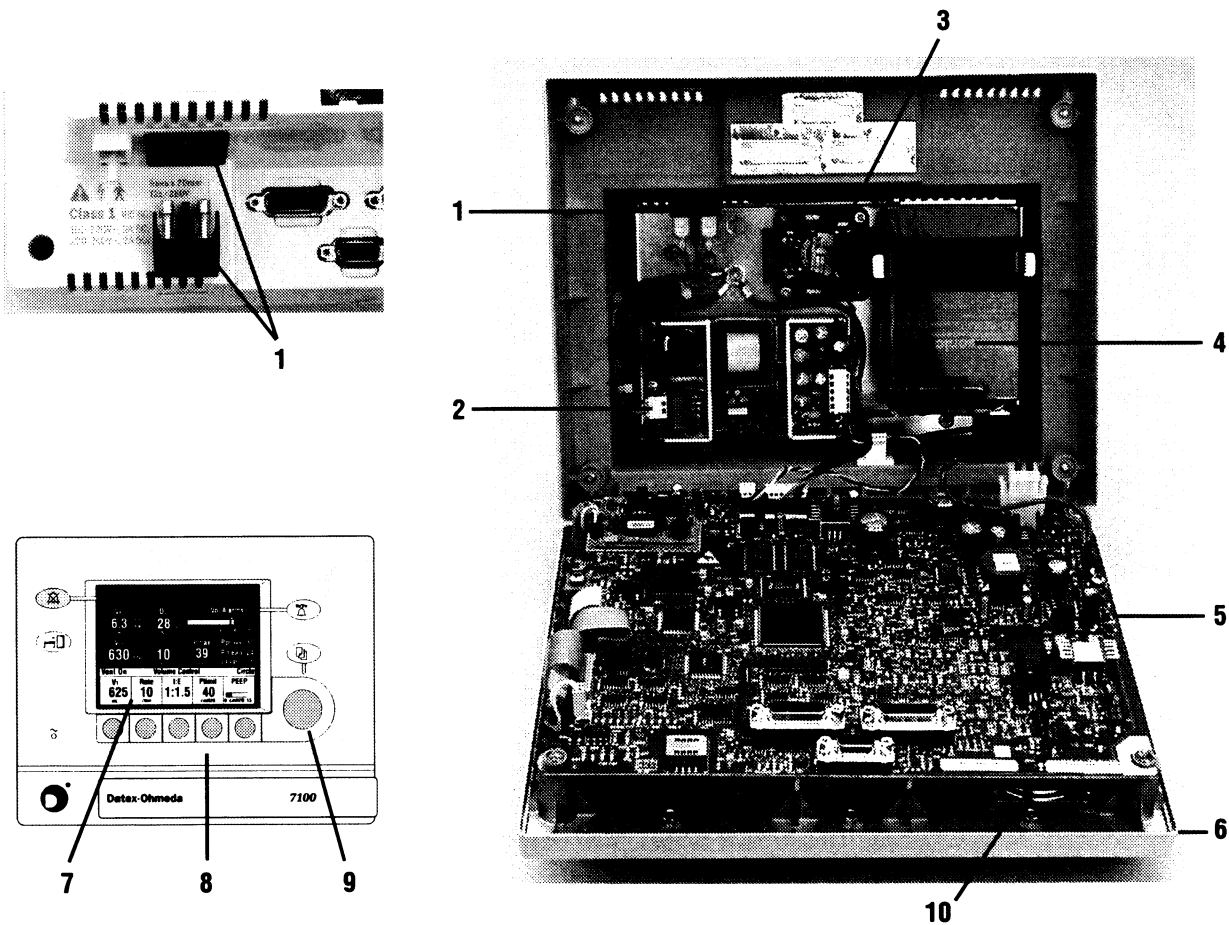

Figure 2-4 • 7100 ventilator control module

2.3.2 Monitoring interface

The Monitoring Interface Assembly (MIA) in the Aestiva machine or the Ventilator Monitoring Board (VMB) in the Aespire machine serves as the interface between the ventilator's control board and the breathing system sensors and switches:

- the inspiratory and expiratory flow sensors
- the O₂ sensor
- the Bag/Vent switch
- Module ID board switches (for the Aestiva machine). The Aespire VMB is hardwired to indicate a Circle module.
- the canister release switch (in the Aestiva machine). The Aespire machine does not indicate an open canister.
- the absorber bypass switch (in the Aestiva machine).
- the control panel switch (in the Aestiva machine). The Aespire machine uses this signal to indicate that the ABS breathing system is disengaged.
- the Auxiliary Common Gas Outlet (ACGO) switch

The MIA for the Aestiva 7100 ventilator is located under the front and rear subfloors of the breathing system (below the bulkhead). The VMB for the Aespire 7100 ventilator is located under the tabletop (below the worksurface).

2.3.3 Serial interface

The Serial Adapter Board (SAB) in the Aestiva machine or the Serial Interface and Connection Board (SICB) in the Aespire machine provides two functions. It serves as the interface between the ventilator's control board and additional switches located in the machine and channels serial communications signals from the controller board to the RS232 connector.

The machine switches include:

- the System On/Standby switch
- the O₂ supply pressure switch
- the O₂ flush switch

The SICB in an Aespire machine also includes an on/off signal through the RS232 connector to a remote monitor.

2.3.4 The Pneumatic Vent Engine

The Pneumatic Vent Engine components in the Aestiva machine or the Aespire machine are identical; however, the complete assemblies are not interchangeable due to packaging considerations. The pneumatic engine enclosure is located in the back chamber of the breathing system and is shielded to contain EMI emissions. The enclosure includes the Pneumatic Vent Engine (PE/VE) and a Pneumatic Vent Engine control Board (PEB/VEB).

The Pneumatic Vent Engine comprises the hardware that drives the ventilator bellows. It includes:

- a 2-micron inlet filter
- a pressure regulator
- a proportional inspiratory valve
- a mechanical over-pressure relief valve
- a free-breathing check valve
- a PEEP safety valve
- a supply pressure sense switch
- a proportional PEEP valve
- a 200 mL reservoir
- a calibrated bleed orifice

The Pneumatic Vent Engine Board is an interface between the engine components and the control board and includes:

- an airway pressure transducer

2.4 Electronic and electrical components

2.4.1 The Aestiva 7100 ventilator functional blocks

The Aestiva 7100 ventilator electronic/electrical subassemblies or modules include:

- a **Power Supply** for operation under line power and a **backup battery** for limited operation in case of power failure;
- a **Control Board** with digital, analog and power circuits to manage all operations of the ventilator;
- a **Front Panel Assembly** that includes an **LCD display** for display of all ventilation and monitoring parameters and a **keyboard** for operator input;
- a **Monitoring Interface Assembly** to preprocess patient circuit parameters and to channel the breathing system switch states;
- a **Serial Adapter Board** to channel machine switch states and to provide a RS232 serial output for external communication.

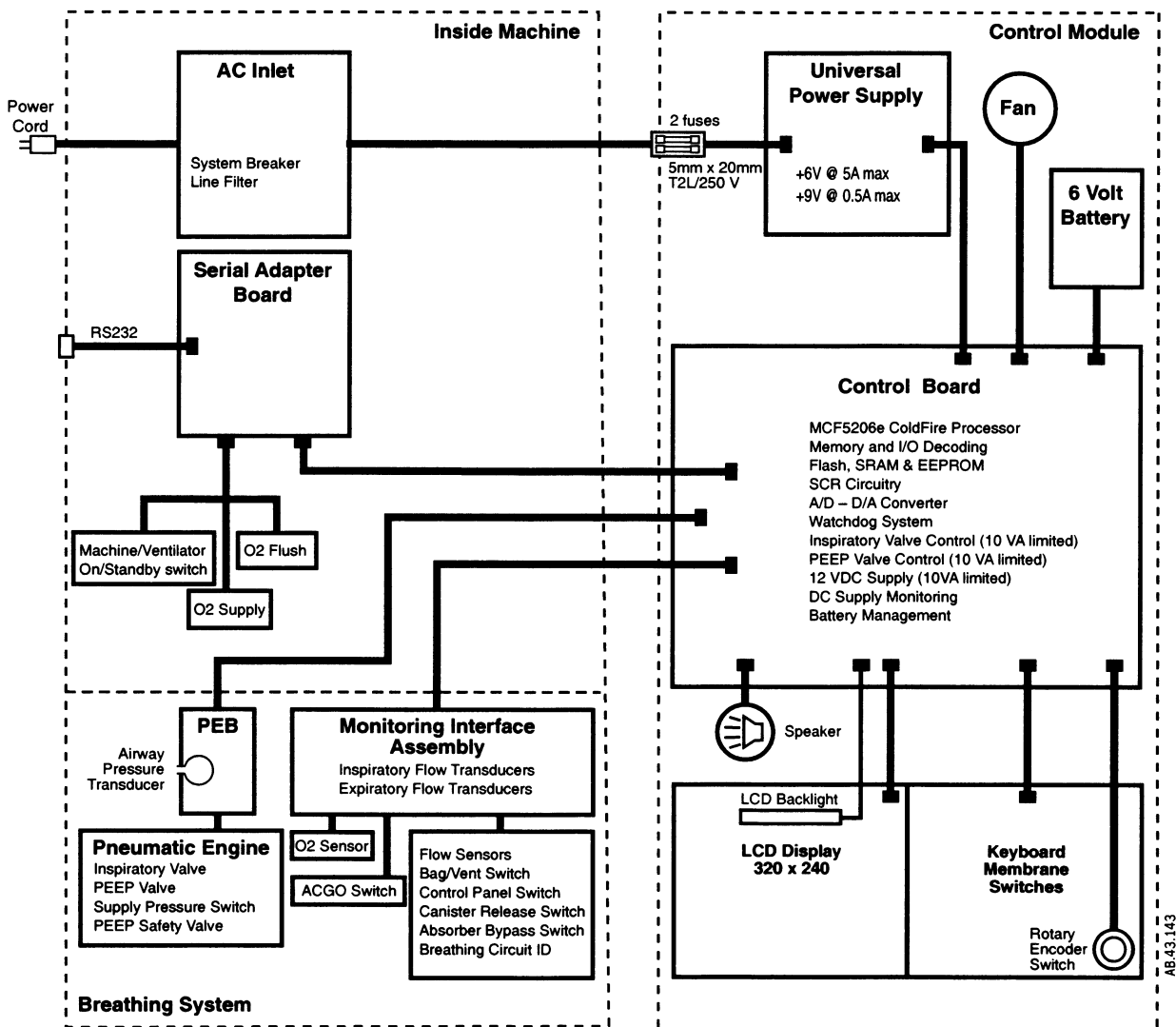

Figure 2-5 • Electronic functional block diagram as used in an Aestiva machine

2.4.2 The Aespire 7100 ventilator functional blocks

The Aespire 7100 Ventilator electronic/electrical subassemblies or modules include:

- a **Power Supply** for operation under line power and a **backup battery** for limited operation in case of power failure;
- a **Control Board** with digital, analog and power circuits to manage all operations of the ventilator;
- a **Front Panel Assembly** that includes an **LCD display** for display of all ventilation and monitoring parameters and a **keyboard** for operator input;
- a **Ventilator Monitoring Board** to preprocess patient circuit parameters and to channel the breathing system switch states;
- a **Serial Isolation Connection Board** to channel machine switch states and to provide a RS232 serial output for external communication.

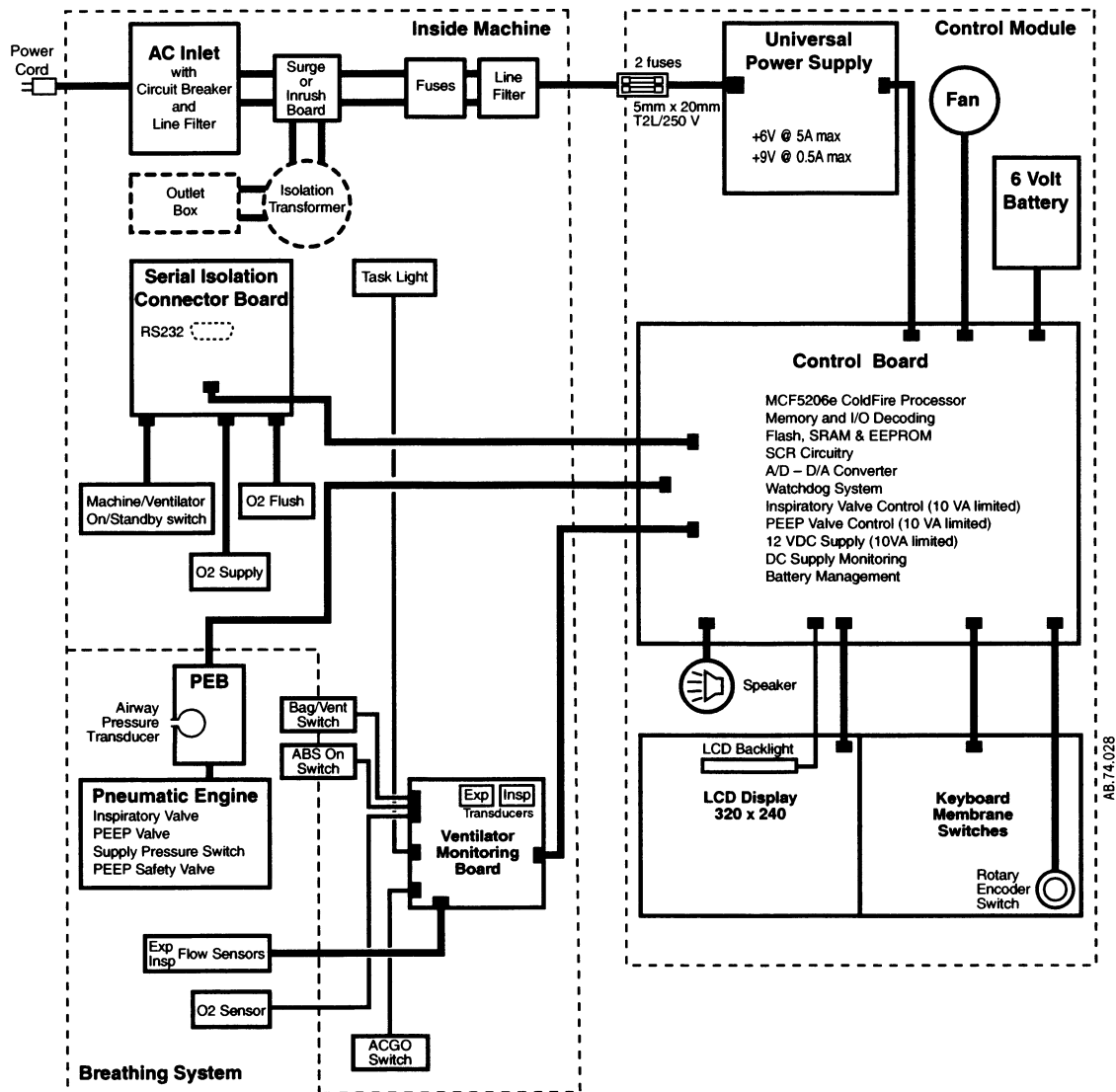

Figure 2-6 • Electronic functional block diagram as used in an Aespire machine

2.4.3 Power Supply

The power supply receives AC input from the machine's AC Inlet Module. The power supply is a universal 40 watt switching supply that outputs two DC voltages. The DC voltages are routed to the Control Board where they are further regulated to produce the power requirements for the 7100 ventilator system.

- **Input:**
Universal 85–264 VAC 47–63 Hz
- **Output V1:**
6.0 VDC ($\pm 0.5\%$) at 0–5 A
- **Output V2:**
9.0 VDC ($\pm 5\%$) at 0–0.5 A

⚠ WARNING

High voltage in area of ⚡ symbol.

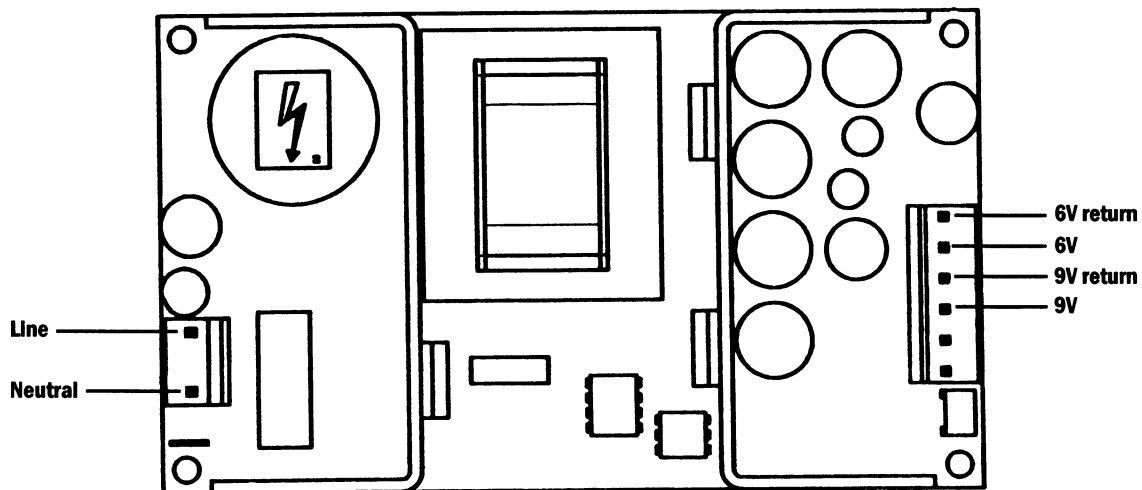

Figure 2-7 • 7100 Ventilator power supply

2.4.4 Sealed Lead Acid Battery

A sealed lead acid battery supplies battery backup for the 7100 ventilator. Since it only provides power in case of a power failure, the battery is in a float charge state most of the time.

The battery meets the following:

- capacity to operate ventilator system for 30 minutes (fully charged);
- long float charge life;
- the battery is internally fused (auto-resettable).

Input: Nominally 6.8 VDC at 25°C during float charge.

Output: +0.6 to +6 Amps during discharge

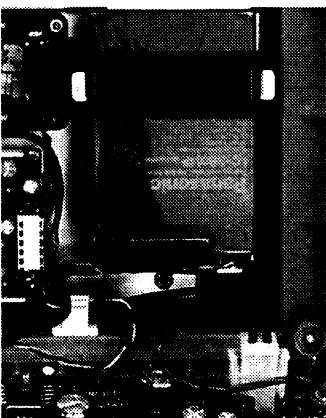

2.4.5 Control Board

The Control Board contains all of the major circuit functions necessary to control ventilator operation.

The Control Board comprises three functional circuit types:

- power circuits,
- analog circuits,
- digital circuits.

These circuits are detailed individually in the following sections.

Overall, the Control Board's functions include:

- Bus access control signals for all memory and peripheral devices
- Interrupt handling
- Clocks and timers for the system
- RS232C serial I/O
- Baud rate generator for serial port
- Hard (power-up) and soft (watchdog error) reset generation
- Data bus buffers
- Memory and I/O decoding
- Program memory with "memory stick" software upgrade
- Safety Relevant Computing (SRC)
- Watchdog system
- Data acquisition
- Flow valve control
- PEEP valve drive and PEEP safety valve drive
- Front panel interface
- Audio alarm

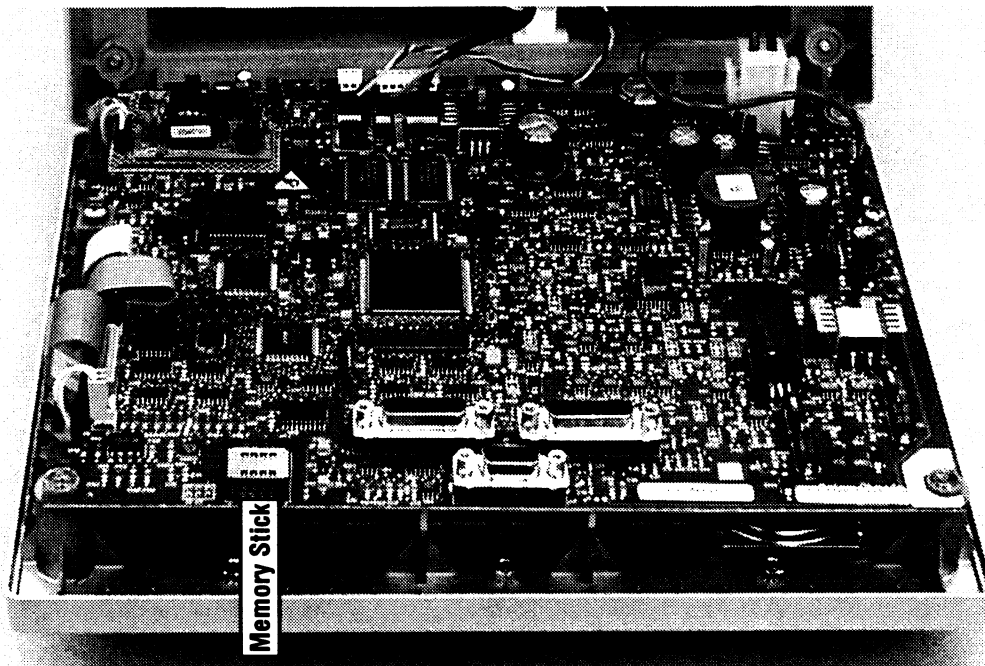

Figure 2-8 • Control board

2.4.5.1 Control Board Power Circuits

The power section of the controller board receives the 6 VDC and the 9 VDC outputs from the power supply.

The 9 VDC supply is used to charge the backup battery.

The 6 VDC supply is processed further to supply various power requirement throughout the 7100 ventilator. In case of power failure, the battery is switched in to supply power.

- power to drive the fan (5V)
- 5V supply for digital circuits
- 3.3V supply for the CPU
- 5V supply for the LCD display backlight
- -24V adjustable supply for the LCD display contrast adjustment
- 1.5A supply for control of the Inspiratory and PEEP valves
- +12V supply for analog circuits
- +12V supply for the Monitoring Interface Assembly
- -12V supply for analog circuits

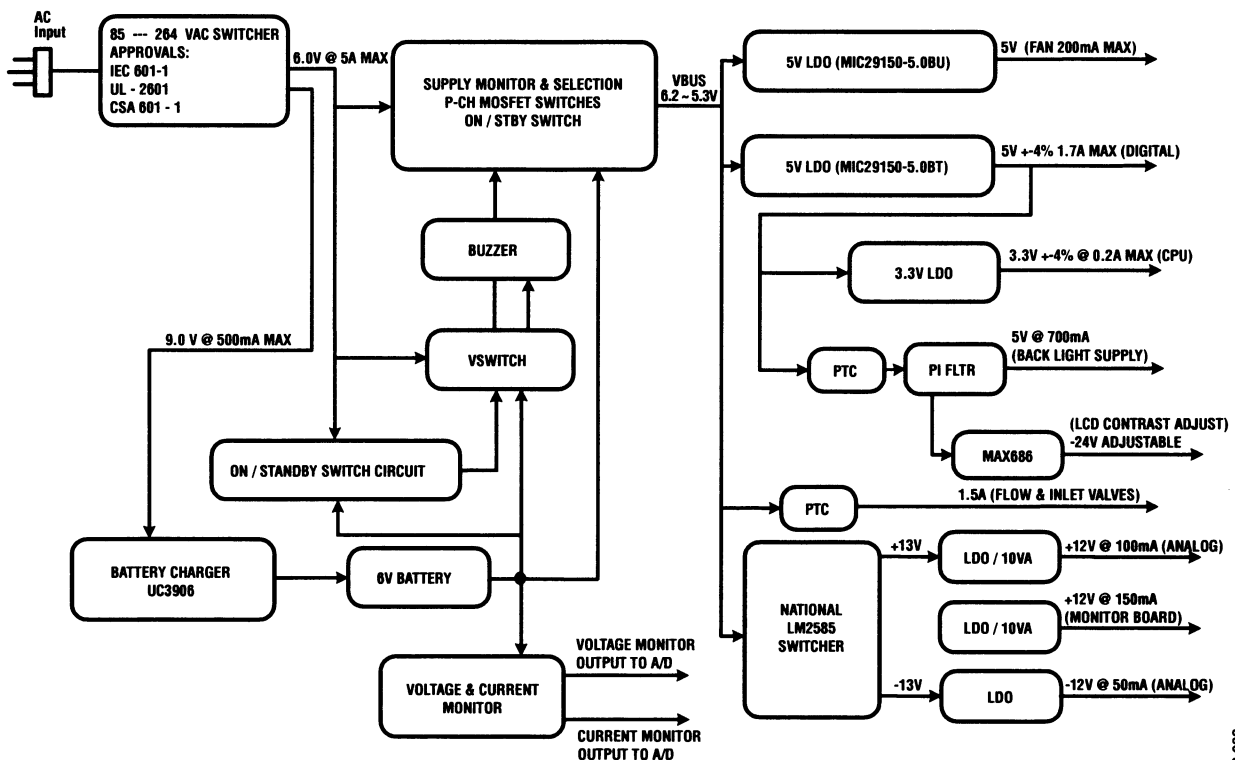

AB-43.092

Figure 2-9 • Control board block diagram - Power circuits

2.4.5.2 Control Board Analog Circuits

The analog section of the controller board processes inputs from the Monitoring Interface Board and the Pneumatic Engine Board. It multiplexes the inputs for display by the digital section.

- Inspiratory flow
- Expiratory flow
- Airway O₂
- Airway pressure

Under the control of the digital section, the analog section includes drivers for the pneumatic engine components:

- flow valve (inspiratory valve)
- PEEP valve
- PEEP safety valve

The switch signals from the Monitoring Interface Board and the supply pressure signal from the Pneumatic Engine Board are passed on as inputs to the digital section.

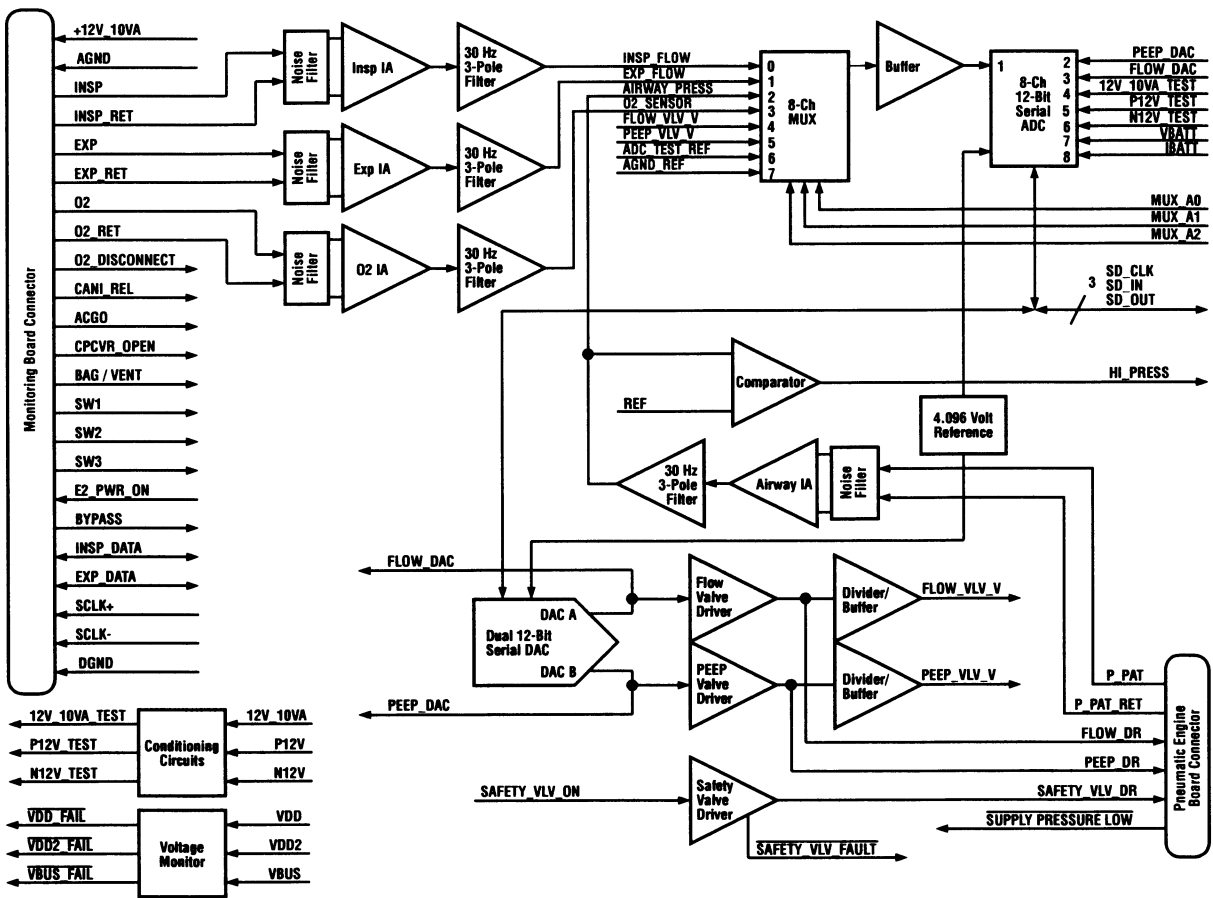

AB.43.093

Figure 2-10 • Control board block diagram - Analog circuits

2.4.5.3 Control Board Digital Circuits

The digital section of the controller board includes a MCF5206e ColdFire microcontroller. The 7100 operating software is stored in 2MB of 8-bit (1Mx16) Flash ROM and includes 1MB of 8-bit (512Kx16) static RAM (SRAM) for operation.

The controller receives switch inputs from the front panel keyboard and the system switch inputs from the Monitoring Interface Board, the Serial Interface Board and the Pneumatic Engine Board.

The patient circuit parameters are multiplexed through the analog section.

The LCD Display is driven through the Video Controller. It displays the processed patient circuit parameters along with the derived alarm and system condition messages.

Additional outputs include an audio amplifier to drive the speaker and a RS232 driver for external communication through the Serial Interface Board.

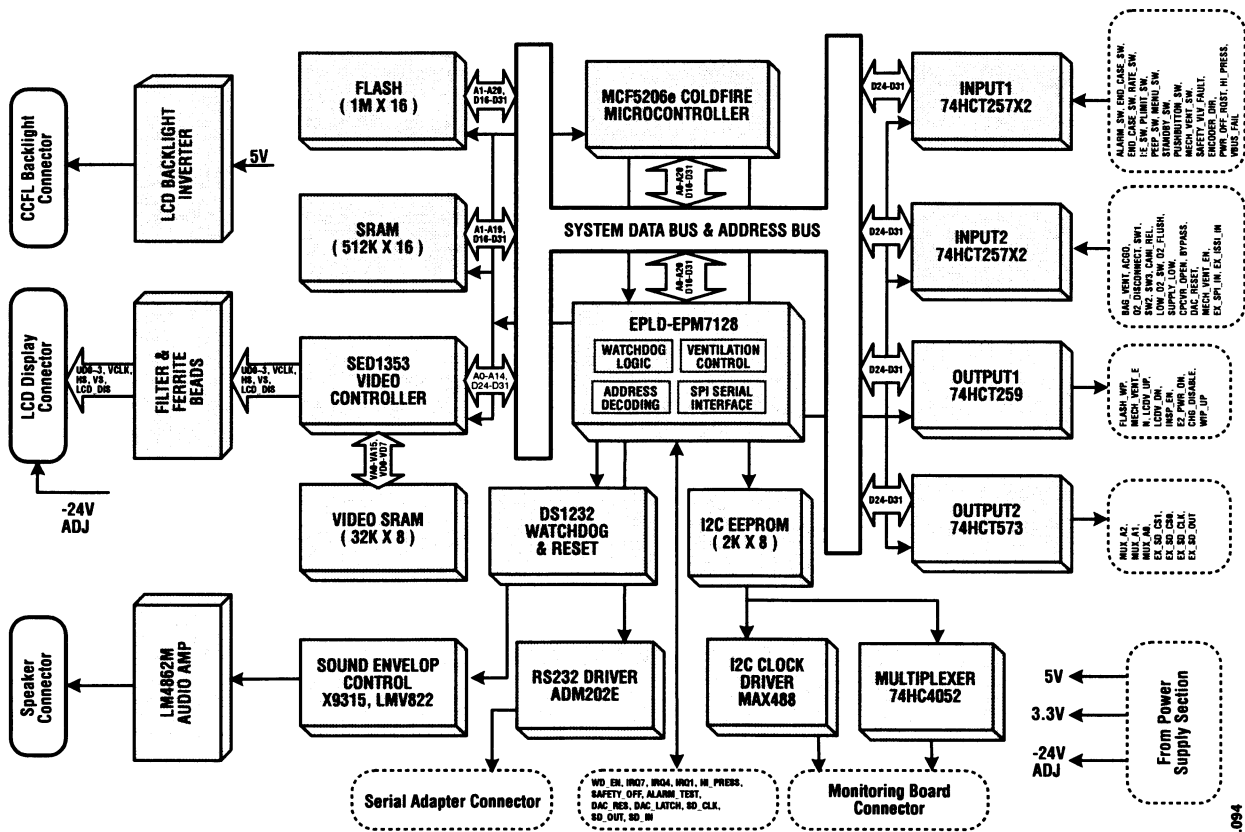

Figure 2-11 • Control board block diagram - Digital circuits

2.4.6 Monitoring interface

The breathing circuit monitoring interface (MIA in the Aestiva machine and VMB in the Aespire machine) is the interface between the patient circuit sensors (the inspiratory and expiratory flow sensor, the O₂ sensor) and the ventilator control module. It also passes different switch functions through to the ventilator control module. These switches are used to show the position of covers, breathing circuit modules and pneumatic controls in the breathing circuit.

Respiratory gas flow, to and from the patient, is monitored by measuring the differential pressure across a variable orifice in each flow sensor. The pressure transducers for measuring the differential pressure are on the MIA/VMB. Conditioning circuitry is supplied for these transducers and for the Oxygen sensor used in the breathing circuit.

Pressure sense tubing and signal wiring is routed from the sensors and switches in the breathing system to the MIA/VMB. A separate cable, routed through the breathing system and the machine proper, transfers power and signals to and from the Control Board.

Notes regarding VMB:
 SW1, SW2, and SW3 are hard wired at the Control Board Connector to indicate a Circle Module.
 The CPCVR_OPEN signal is renamed ABS_ON.
 The BAG/VENT and the ABS_ON signal arrive at the O₂ Sensor Connector.
 The VMB includes a 100 mA Current Source that supplies power to the Task Light from the +12V line.

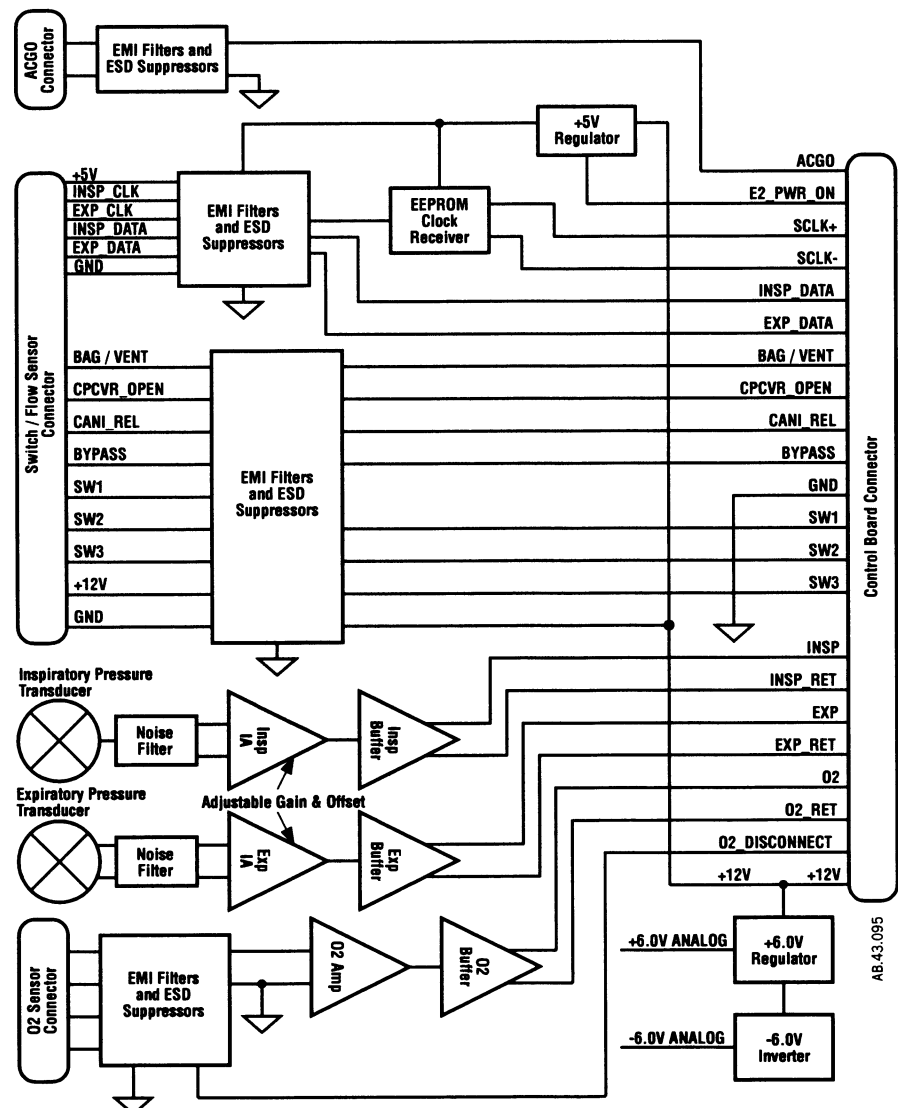

Figure 2-12 • Breathing Circuit Monitoring Interface Assembly (MIA)

2.4.7 Serial interface

The serial board (SAB/SICB) provides two functions:

- It serves as an interface between the control board and switches that are located in the machine itself (not in the breathing system).
- It processes serial communications signals from the control board to the RS232 connector (COM 1) on the back panel of the Aestiva machine.

Machine Switches

The machine switches include:

- the System On/Standby switch
- the O₂ supply pressure switch
- the O₂ flush switch

Serial Communications

The serial interface provides isolated RS232 serial communications. The TXD (transmit) and RXD (receive) signals between the SAB and the control board are at RS232 levels.

Circuits on the board change the signals to digital 5V levels; isolate them through optocouplers; then, change them back to RS232 levels before sending them to the outside world.

- The external communications signals conform to standard RS-232C signal standards.
- COM 1 is a 15-pin female D connector.
- It's configured for Data Communications Equipment (DCE)
- Pin 6 - receive data
- Pin 13 - transmit data
- Pin 5 - signal ground

In addition to the above, the SICB in the Aespire machine provides remote monitor On/Off through an isolated relay.

- Pin 1 - MON On/Standby
- Pin 9 - MON On/Standby return

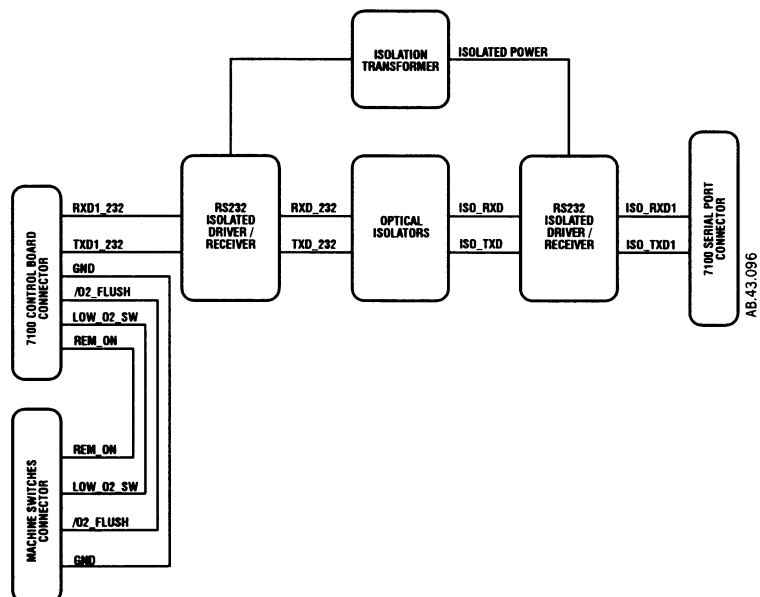

Note regarding SICB:

The machine switch signals come in on three separate connectors.

2.4.8 Pneumatic Vent Engine Board

The Pneumatic Vent Engine Board (PEB/VEB) provides two functions:

- It serves as an interface between the control board and the pneumatic engine.
- It processes the output from the airway pressure transducer.

Pneumatic Engine Interface

The board provides a direct connection for the drive and return lines for the control valves on the pneumatic engine:

- Inspiratory Flow Valve
- PEEP Valve
- PEEP Safety Valve

The board routes the Supply Pressure Switch signals to the control board.

Airway Pressure Transducer

The PEB includes a +5VA regulator to power the airway pressure transducer circuitry. The circuits provide EMI filtering, signal amplification, and buffering.

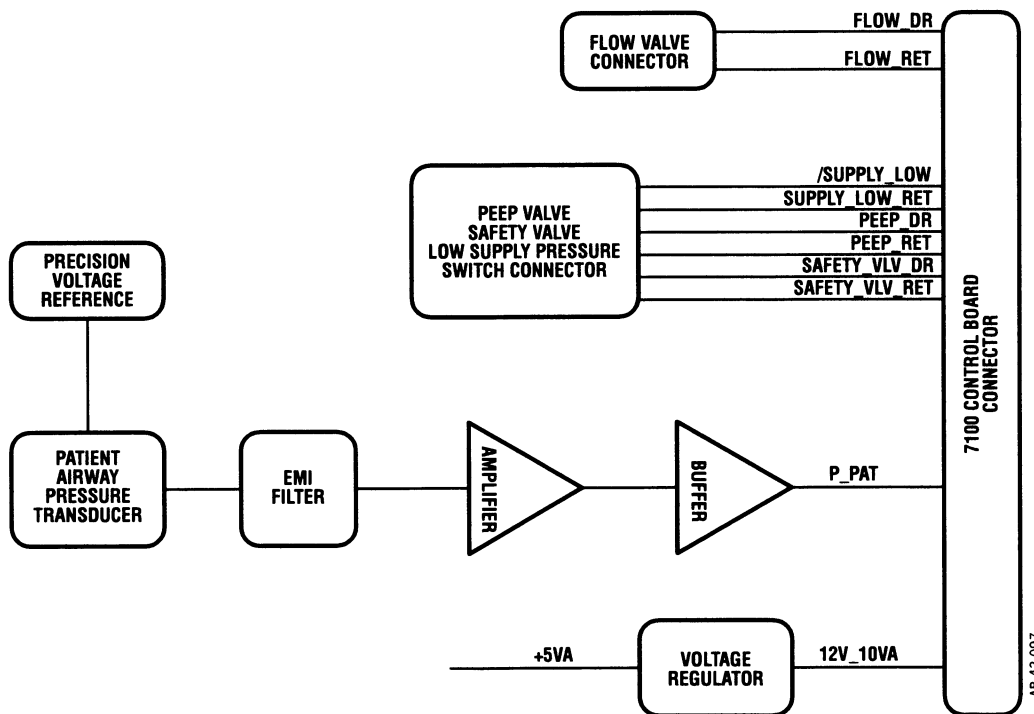

2.5 Mechanical Subsystems

Refer to:

- Figure 9-3, "Aestiva 7100 anesthesia machine pneumatic diagram,"
- Figure 9-4, "Aespire 7100 anesthesia machine pneumatic diagram,"

in section 9 for the complete pneumatic/mechanical subsystem.

The mechanical subsystem includes:

Pneumatic Engine

- Drive gas inlet filter
- Supply gas pressure regulator
- Inspiratory flow control valve
- PEEP valve; PEEP safety valve; Pressure sense switch
- Mechanical Overpressure Valve (MOPV)
- Bleed resistor
- Free breathing valve

Exhalation valve

Breathing circuit flow sensors

Bellows assembly

2.5.1 Supply Gas

Supply gas (can be selected from O₂ or Air) is supplied from the anesthesia machine at a pressure of 241 to 690 kPa (35 to 100 psi). This supply gas is filtered through the 2-micron filter to remove any minute particles of contaminate. The filter does not significantly lower the output pressure on the downstream side of the filter.

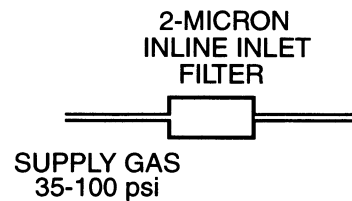

Aestiva Engine

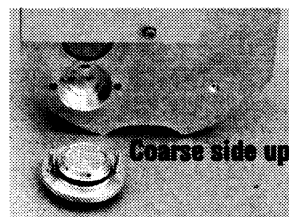

Aespire Engine

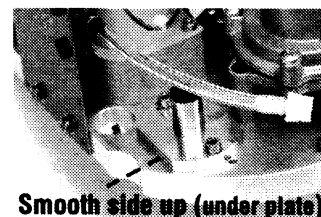

2.5.2 Pressure Regulator

The pressure regulator is a non-relieving pressure regulator that regulates high pressure filtered supply gas, oxygen or medical air, down to 172 kPa (25 psi).

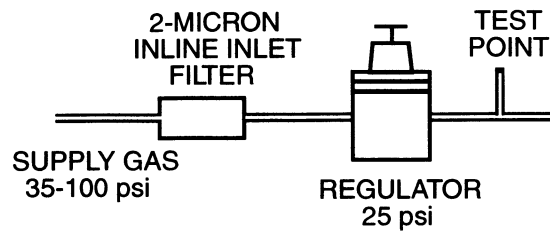
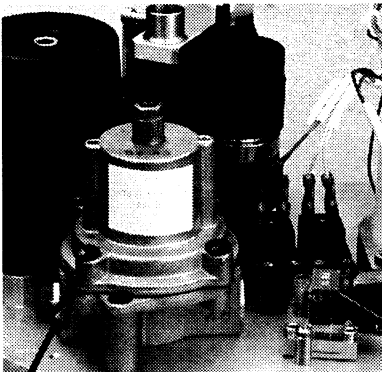

2.5.3 Inspiratory Valve

The inspiratory control valve is cycled by the control board to supply drive gas to the outer chamber of the bellows assembly at a rate determined by ventilator settings and sensor signals. The control valve modulates the incoming 172 kPa (25 psi) drive gases to an output from 0 to 70 liters per minute at pressures ranging from 0 to 100 cm H₂O.

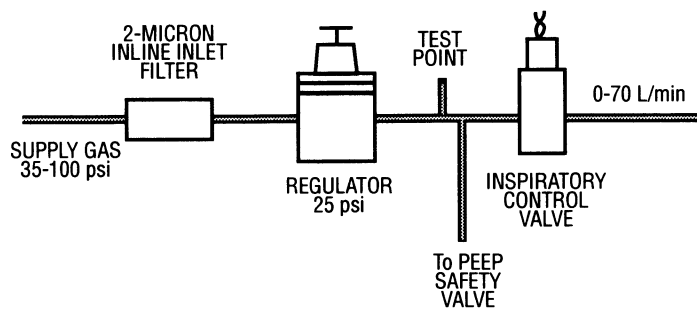
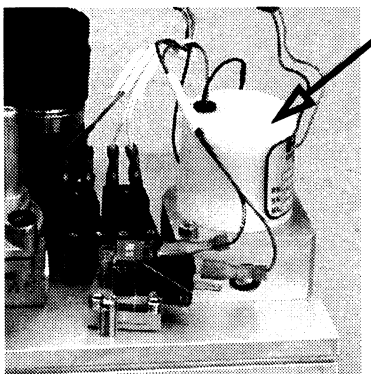

2.5.4 Exhalation (PEEP) Control

The exhalation valve contains an elastomeric diaphragm that is used to control the pressures in the breathing circuit.

The exhalation valve is normally open. When the exhalation port is open, gas flows from the bellows housing to the scavenging port. Approximately 2 cm H₂O of pilot pressure is necessary to close the valve. Pilot control of the exhalation valve is done with PEEP Control Valve (A), Supply Pressure Switch (B), and the PEEP Safety Valve (C).

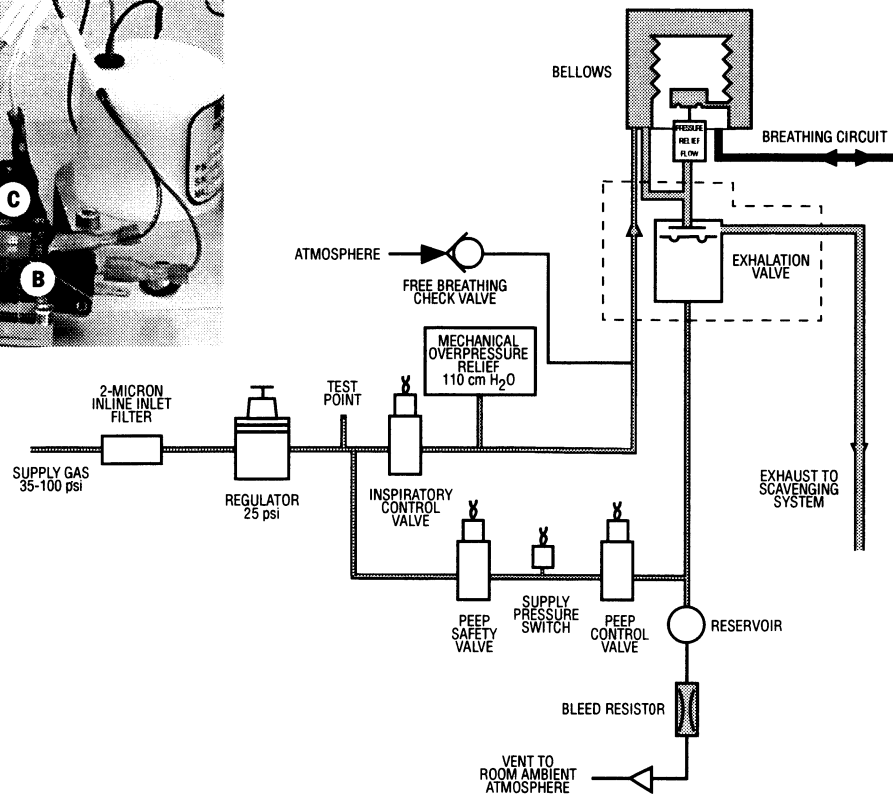
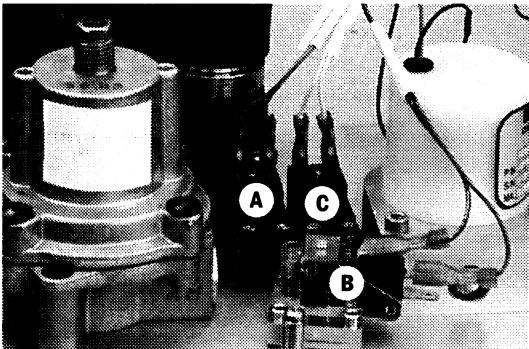
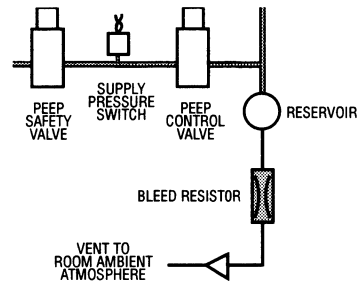
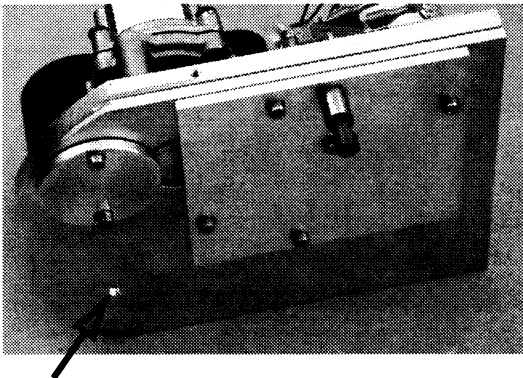

Figure 2-13 • Exhalation manifold

2.5.5 Bleed Resistor

The bleed resistor is a “controlled leak” from 0 to 10 L/min in response to circuit pressures from 0 to 100 cm H₂O. The small quantity of pneumatic flow exhausting through the bleed resistor permits control of the exhalation valve's pilot pressure by modulation of the valve output. The bleed resistor exhausts only clean drive gas and must not be connected to a waste gas scavenging circuit. The output is routed away from the electrical components to make sure that systems using oxygen drive gas meet the 10VA limitation requirement for oxygen enrichment.



2.5.6 Bellows Pressure Relief Valve

The Bellows assembly is the interface between drive gas and the patient circuit in the breathing system. The pressure relief valve (or pop-off valve) in the bellows assembly limits pressure in the patient circuit. Excess fresh gas is discharged through the exhalation valve into the gas scavenging system.

The Bellows Pressure Relief Valve (PRV) is normally closed, maintaining approximately 1.5 cm H₂O in the breathing circuit in a no flow condition, enough to keep the bellows inflated. It is piloted closed during inspiration and remains closed until the bellows is refilled during exhalation. If the pressure in the patient circuit exceeds 4 cm H₂O, the pop-off valve opens to exhaust excess fresh gas flow at a rate up to 4 L/min.

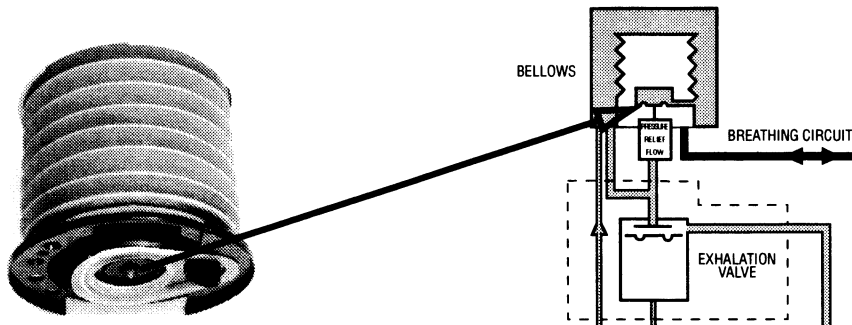

2.5.7 Mechanical Overpressure Valve

The Mechanical Overpressure Valve (MOPV) is a mechanical valve that operates regardless of electrical power. It functions as a third level of redundancy to the ventilator's pressure limit control functions, supplying pressure relief at approximately 110 cm H₂O.

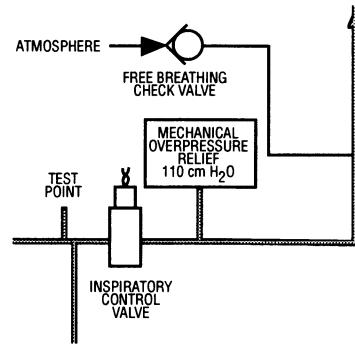
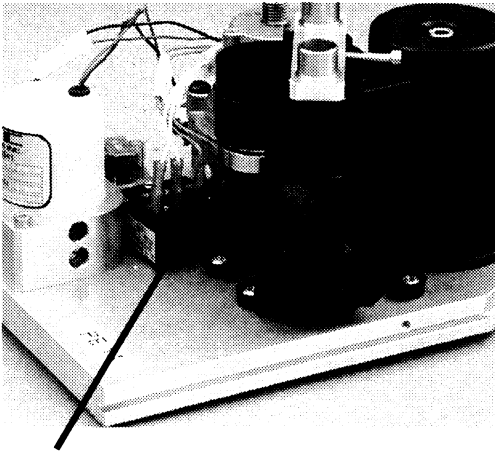

2.5.8 Free Breathing Valve

The ventilator is programmed to supply a specified number of breaths per minute to the patient. If, in between one of these programmed cycles, the patient needs a breath (spontaneous), the free breathing valve permits the patient to inhale. The free breathing valve is closed on mechanical inspiration.

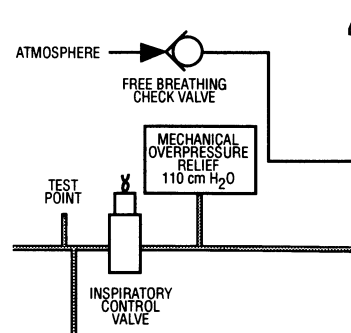
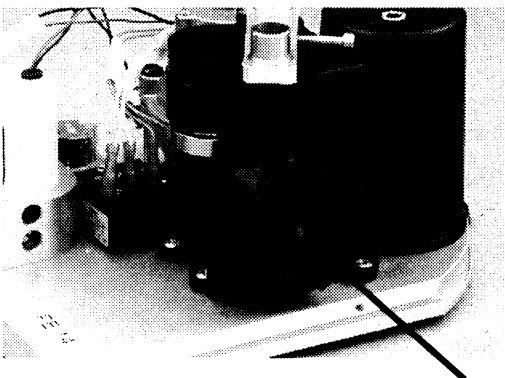

2.5.9 Breathing Circuit Flow Sensors

Two flow sensors are used to monitor inspiratory and expiratory gas flow. The inspiratory flow sensor is downstream of the breathing system inspiratory check valve. Feedback from the inspiratory transducer is used to supply tidal volumes that make allowances for the effects of fresh gas flow and circuit compressibility. The expiratory flow sensor is located at the input to the breathing system expiratory check valve. Feedback from the expiratory flow sensor is used to supply signals for the expiratory tidal volume monitoring.

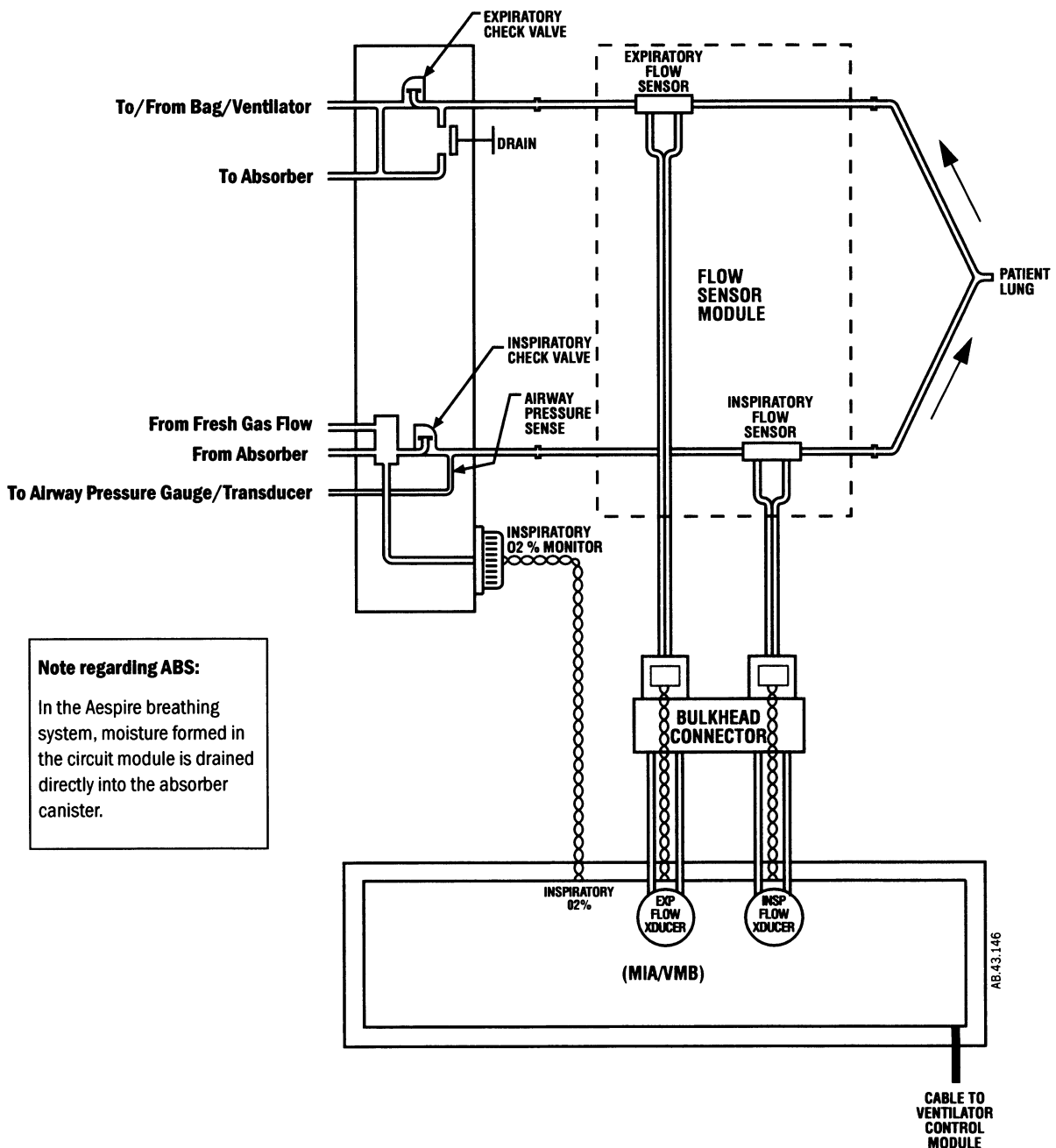

Note regarding ABS:
In the Aespire breathing system, moisture formed in the circuit module is drained directly into the absorber canister.

3 Post-Service Checkout

In this section	3.1 Post-service checkout	3-2
	3.1.1 Test the 7100 ventilator	3-2
	3.1.2 Test the anesthesia machine	3-2

3.1 Post-service checkout

After servicing the 7100 ventilator, perform the following service mode Calibrations:

- O₂ Calibration
- Zero Flow and Airway Sensors
- Adjust Drive Gas Regulator
- Airway Sensor Span
- PEEP Valve Calibration
- Inspiratory Valve Calibration
- Pressure Sensitivity

Then, you must complete the checkout procedure for the entire machine:

- the 7100 ventilator (refer to Section 3.1.1)
- the anesthesia machine (refer to Section 3.1.2)
- and all the accessories and options.

⚠ WARNING You must perform all post-service checks after maintenance or service of the ventilator. Failure to do so may result in patient injury.

⚠ WARNING All components and accessories must be connected correctly. All hoses and cables must be properly connected before returning the anesthesia machine to clinical use. Failure to do so may result in patient injury.

3.1.1 Test the 7100 ventilator

Perform the **Preoperative Checkout Procedure** that applies:

- in Part 2 of the Aestiva/5 7100 User's Reference Manual.
- in Part 2 of the S/5 Aespire User's Reference Manual.

3.1.2 Test the anesthesia machine

The 7100 ventilator is an integral component of the Aestiva or the Aespire anesthesia machine.

To be certain the ventilator is functioning correctly, test the entire system.

For the proper checkout procedures, refer to the following document that applies:

- the **Aestiva Anesthesia Machine Technical Reference Manual**.
- the **Aespire Anesthesia Machine Technical Reference Manual**.

4 Tests and Calibration

⚠ WARNING: Post-Service Checkout is required after you complete this section. You must perform *Section 3.1 Post-service checkout* after performing any maintenance, service or repair. Failure to do so may result in patient injury.

In this section

To ensure proper operation, the 7100 Ventilator includes several tests that run automatically (self tests) and a series of menu pages that a qualified service person can use to test, calibrate, or troubleshoot ventilator related components in the anesthesia machine (Service Mode).

4.1 Self tests	4-2
4.2 Service Mode	4-3
4.3 About Ventilator	4-4
4.4 Alarm Log	4-5
4.5 Error Log	4-6
4.6 Language	4-7
4.7 User Settings	4-8
4.7.1 Screen Contrast	4-8
4.8 System Configuration	4-9
4.9 Calibrations	4-11
4.9.1 O2 Calibrations	4-12
4.9.2 Zero Flow and Airway Sensors	4-13
4.9.3 Adjust Drive Gas Regulator	4-14
4.9.4 Airway Sensor Span	4-15
4.9.5 PEEP Valve Calibration	4-17
4.9.6 Inspiratory Valve Calibration	4-18
4.9.7 Pressure Sensitivity	4-20
4.9.8 Service Calibrations Required	4-22
4.10 Diagnostic Tests/Tools	4-23
4.10.1 Display A/D Channels	4-24
4.10.2 Display Discrete I/O Signals	4-26
4.10.3 Display Battery Status	4-27
4.10.4 Test Panel Switches	4-28
4.10.5 Valves - Test Tool	4-29
4.10.6 Test CPU and Memory	4-30
4.10.7 Test EEPROM	4-31
4.10.8 Test Serial Port	4-32
4.10.9 Test 5V Fail Alarm	4-33
4.10.10 Test Inspiratory Valve	4-34
4.10.11 Test PEEP Valve	4-35
4.10.12 Test PEEP Safety Valve	4-36
4.10.13 Breathing System Leak Test	4-37
4.10.14 Test Pressure Limit Circuit	4-38
4.11 Upgrade Options	4-40

4.1 Self tests

The 7100 Ventilator software includes self tests that determine whether or not the operating software is functioning properly and whether or not the electronic circuits on the circuit boards are functional.

The self tests include:

- powerup tests
- continuous tests
- periodic tests

Powerup tests

The following list of the tests run at powerup:

- Sequential watchdog
- Logical watchdog
- Data RAM walking pattern test
- FLASH ROM CRC verification
- PEEP Valve test
- PEEP Safety Valve test

If one or more of these tests fail, the display provides a readout of the problem.

Continuous tests

These tests are run continuously during normal operation and alarms are associated with each test. A failure causes an alarm to display on the screen in the alarm display area.

- Supply voltage checks
- Battery voltage checks

Periodic tests

These tests are run every 30 seconds during normal operation. Alarms are associated with each test. A failure causes an alarm to display on the screen in the alarm display area.

- CPU Test
- Display RAM walking pattern test
- Data RAM walking pattern test
- FLASH ROM CRC verification
- Inspiratory control valve DAC and voltage feedback
- PEEP control valve DAC and voltage feedback

4.2 Service Mode

The **Service Mode** is used to test, calibrate, or troubleshoot ventilator related components in the anesthesia machine.

There are two ways to enter the service mode:

- If the machine is turned off, push and hold in the adjustment knob while setting the system switch to On. Hold the adjustment knob pushed in until the “Service Confirmation” menu appears. Use the adjustment knob to highlight “Service Mode”, then push the adjustment knob to confirm the selection.
- If the machine is already in normal operation, set the Bag/Vent switch to Bag. Then, press the V_T /Pinsp, the PEEP, and the menu switches at the same time to reset the software (powerup). Push and hold the adjustment knob until the “Service Confirmation” menu appears.

Note: Volume alarms must be in standby.

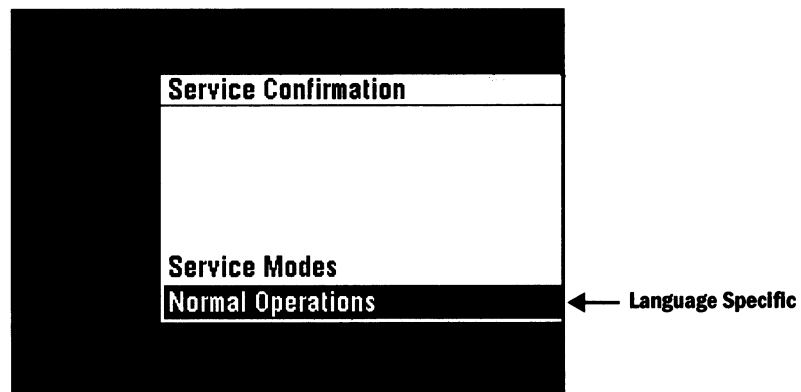

From this menu you can:

- Go to the Service Modes
- Return to Normal Operations

Service Modes Menu

The **Service Modes** main menu displays the service tests you can select.

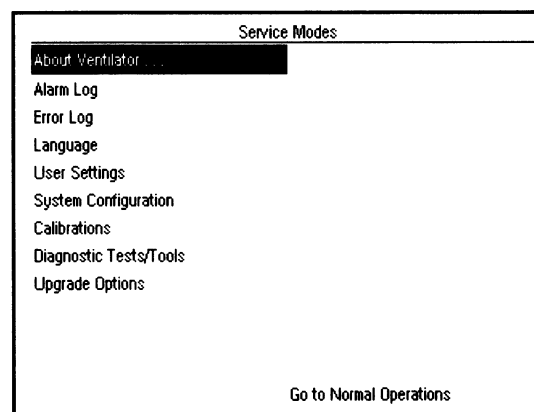

The selectable service tests are displayed in categorical order. But you can select the service test from this menu in any order. The following sections in this manual are sequenced in the order that they appear on the screen.

4.3 About Ventilator

The **About Ventilator** menu identifies the current software loaded into the ventilator's Flash-ROM memory and displays the total "on time" of the system.

- **Software Version**
- **Software Date**
- **Hardware ID**
- **Total System On Time**
- **Current Bootup Count** – The bootup count is incremented each time the machine is turned on. The bootup count is not overwritten when new software is loaded. However, if a new control board is installed, the bootup count will reflect the value stored in the EEPROM of the new board.

About Ventilator . . .	
Software Version:	1.1
Software Date:	Aug 28 2000 11:31:43
Hardware ID:	3
Total System On Time:	0 Year(s) 0 Day(s) 0 Hour(s) 0 Minute(s)
Current Bootup Count:	1

[Go to Service Modes Menu](#)

4.4 Alarm Log

The **Alarm Log** displays up to 20 of the most current alarm messages that have been logged. Each log entry shows:

- **Bootup Count** number (the bootup count is incremented each time the machine is turned on).
- **Time (ms)** – the time in milliseconds since bootup when the latest alarm condition occurred.
- **Alarm** message associated with the particular alarm condition.
- **# Times** – the number of times that the specific alarm condition has occurred during the noted bootup count.

The bottom-left corner of the screen displays additional information:

- **Bootup Count Last Cleared**
- **Current Bootup Count**

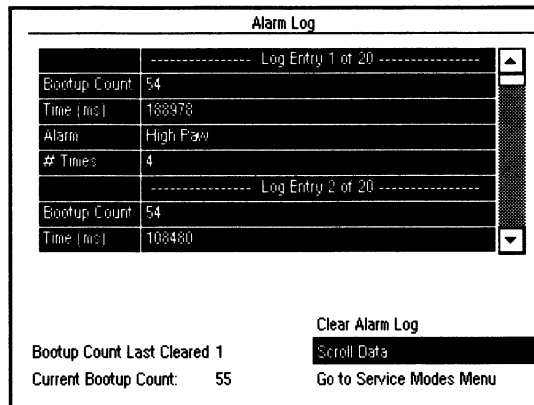

Scroll Data To view all the log entries, select “Scroll Data.” Then, use the control knob to scroll through the entries.

To exit Scroll Data, press the control knob.

Clear Alarm Log To clear the alarm log, select “Clear Alarm Log.” The system asks you to confirm that you want to clear the alarm log.

Remarks After you clear the alarm log:

- the “Bootup Count Last Cleared” number will be reset to the “Current Bootup Count” number.
- the menu will show the message “No entries in log!”.

4.5 Error Log

There are two special types of alarms:

- Minimum monitoring alarms that stop mechanical ventilation
- Minimum shutdown alarms that stop mechanical ventilation and monitoring.

An alarm message that results from these special types of alarms is considered an error alarm.

The **Error Log** displays up to 20 of the most current Error messages that have been logged.

Each log entry shows:

- **Bootup Count** number (the bootup count is incremented each time the machine is turned on).
- **Time (ms)** – the time in milliseconds since bootup when the latest alarm condition occurred.
- **Error** message associated with the particular alarm condition.
- **Address** – the place in the software sequence where the last occurrence of the error took place.

The error address and software revision are important pieces of information to note if technical support is required.

The bottom-left corner of the screen displays additional information:

- **Bootup Count Last Cleared**
- **Current Bootup Count**

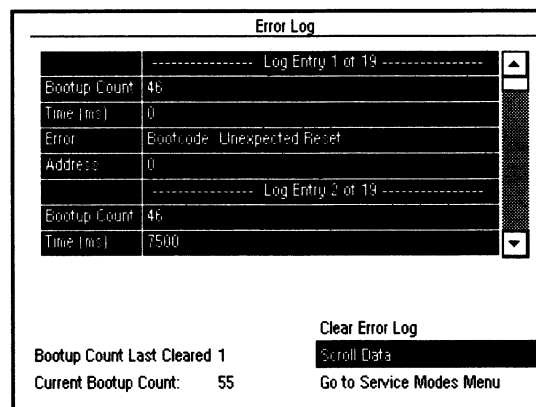

Scroll Data

To view all the log entries, select “Scroll Data.” Then, use the control knob to scroll through the entries. To exit Scroll Data, press the control knob.

Clear Error Log

To clear the error log, select “Clear Error Log.” The system asks you to confirm that you want to clear the error log.

Remarks

After you clear the alarm log:

- the “Boot Count Last Cleared” number will be reset to the “Current Boot Count” number.
- the menu will show the message “No entries in log!”.

4.6 Language

The text shown in the normal mode of operation is language sensitive. However, the Service Confirmation menu (except for text “Normal Operation”) and all the Service Modes menus are shown only in English.

The **Language** menu is used to set the specific language for normal operation.

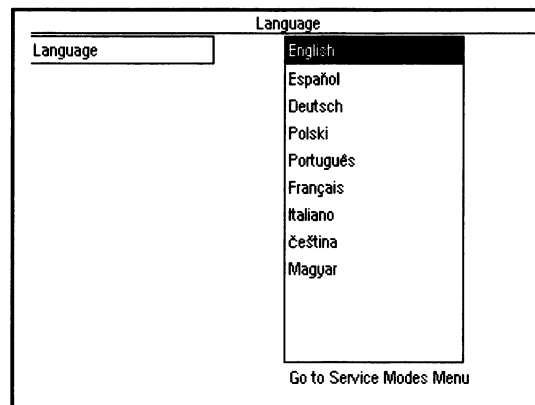

The 7100 ventilator supports the following languages. The language selections appear in language specific text.

- English
- Español Spanish
- Deutsch German
- Polski Polish
- Português Portuguese
- Français French
- Italiano Italian
- Čeština Czech
- Magyar Hungarian
- Nederlands . . . Dutch
- Greek
- Russian
- Japanese
- Chinese

The language setting is stored in EEPROM with the default setting as English.

4.7 User Settings

In normal operation, the user can set several parameters to a personal preference or to compensate for the surrounding influences. The range of some of these settings can vary from machine to machine.

The **User Settings** menu is used to adjust the range to normalized values.

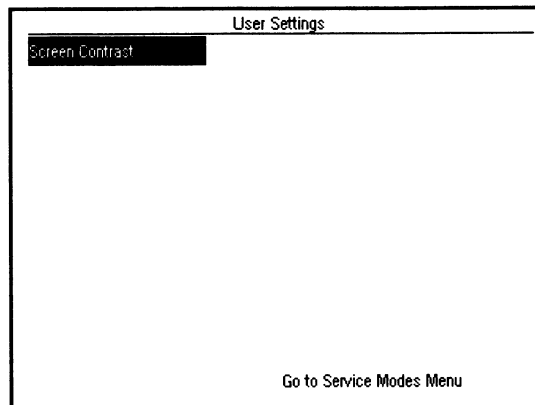

4.7.1 Screen Contrast

The range from minimum to maximum screen contrast varies for individual displays. The **Screen Contrast** menu is used to tailor the range so that the screen image is still visible at minimum and maximum contrast settings for the user.

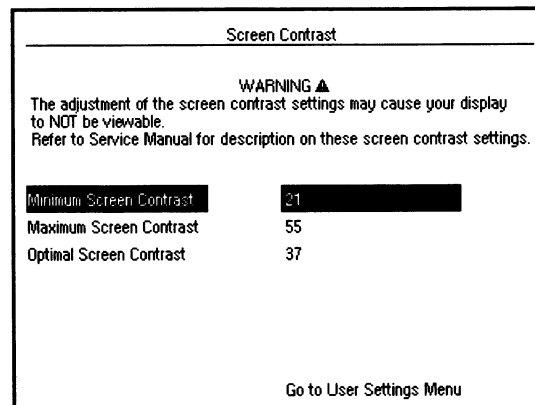

Remarks

The "Minimum Screen Contrast" and the "Maximum Screen Contrast" settings set the range of contrast values for the operator.

The "Optimal Screen Contrast" setting sets the default value.

4.8 System Configuration

The **System Configuration** menu includes settings that are tailored to the specific machine. The “Altitude,” “Drive Gas,” “Heliox Mode,” “ \dot{V}_E Alarm Limits,” “System Type,” and “Flow Sensor Correction” settings are present for all machines. The inclusion of the remaining settings depends on the purchased features for the specific machine.

Altitude	300 m
Drive Gas	O ₂
Heliox Mode	Disabled
\dot{V}_E Alarm Limits	Automatic
System Type	Aestiva
Flow Sensor Correction	Lead Filter Off
O ₂ Monitoring	Enabled
Volume Monitoring	Enabled
Volume Compensation	Enabled
Pressure Mode	Enabled
Pressure Waveform	Enabled
Go to Service Modes Menu	

Set the altitude The accuracy of some of the ventilator measurements is altitude sensitive. To ensure the specified accuracy, the altitude setting should be set to the specific altitude where each machine is located.

Altitude settings range from -400 to 3600 meters in increments of 100 meters.

The setting is saved in EEPROM; the default value is 300 meters.

Select drive gas Either O₂ or Air can be used as the drive gas for the ventilator’s pneumatic engine.

To compensate volume calculations for the specific density of the drive gas used, the drive gas selection on this menu must match the actual drive gas.

To change the actual drive gas, refer to Section 4 of the respective anesthesia machine Technical Reference Manual.

⚠ Caution If you change the drive gas, you must also change the drive gas selection on this service setup screen. If the drive gas selection and the actual drive gas do not agree, volumes will not be correct.

Heliox Mode Enabled – Disabled

Only Aestiva machines can be configured to deliver Heliox. Aestiva machines that include the Heliox option, should have the Heliox Mode “Enabled”. With the Heliox Mode enabled, the operator can choose to turn the Heliox Mode On or Off (on the Setup menu).

All Aespire machines should have the Heliox Mode disabled.

If the machine is not configured to deliver Heliox, the Heliox Mode should be set to “Disabled”. With the Heliox Mode disabled, the user’s “Setup” menu will not include the Heliox option.

Whenever you enable or disable the Heliox Mode, the screen will display the following warning:

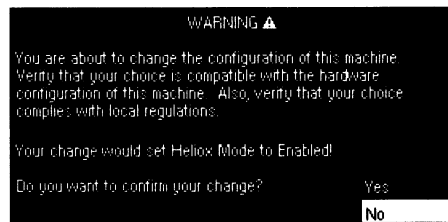

Note A similarly worded warning will appear when you change the “O₂ Monitoring,” “Volume Monitoring,” and the “Volume Compensation” settings.

VE Alarm Limits Automatic – User Adjustable

System Type Aestiva

Currently, the 7100 ventilator is available in the Aestiva machine and the Aespire machine. Since the 7100 ventilator functions identically in either machine, the System Type setting is displayed as “Aestiva.” The cursor will skip over this selection.

Flow Sensor Correction Lead Filter Off – Lead Filter On

This setting relates to the MIA/VMB board. For current MIA/VMB assemblies, this setting should be **Lead Filter Off**.

O₂ Monitoring Enabled – Disabled (if site preference)

May not appear in some configurations.

Volume Monitoring Enabled – Disabled (if site preference)

May not appear in some configurations.

If “Volume Monitoring” is set to “Disabled,” “Volume Compensation” is automatically set to “Disabled.”

Volume Compensation Enabled – Disabled (if site preference)

May not appear in some configurations.

Pressure Mode Enabled – Disabled (if site preference)

May not appear in some configurations.

Pressure Waveform Enabled – Disabled (if site preference)

May not appear in some configurations.

4.9 Calibrations

The **Calibrations** menu includes service level calibrations of components that need periodic adjustment to maintain specified accuracy.

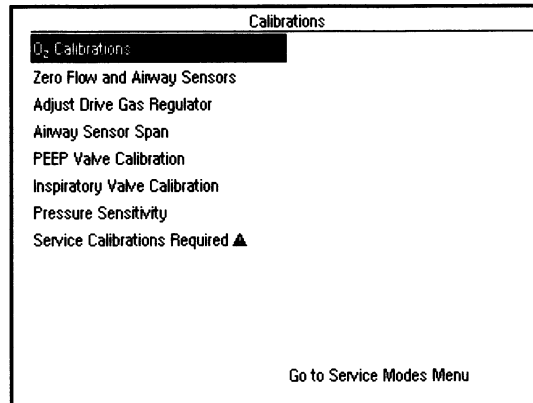

Remarks You can enter these procedure in any order. However, the procedures appear in a logical sequence. Some of the latter procedures require you to have completed some of the earlier procedures.

Additionally, these procedures require you to disassemble and reassemble parts of the breathing system. Accordingly, the procedures are arranged to minimize the disassembly and reassembly process.

4.9.1 O₂ Calibrations

The **O₂ Calibrations** take into account the altitude setting. Before starting the calibrations, ensure that the altitude setting (in "System Configuration" menu) is set to the appropriate altitude for the machine location.

For the "21% O₂ Calibration" software reads the A/D value for the O₂ sensor when the O₂ sensor is exposed to room air (21% O₂).

- If this A/D value is not within the tolerance, the calibration fails.
- If the calibration passes, the A/D value is stored in the EEPROM.

The sensor must be calibrated at 21% O₂ before calibration at 100% O₂.

O₂ Calibrations

Directions for the 21% O₂ calibration:

1. Select the correct altitude using the "System Configuration" page.
2. Remove O₂ sensor from breathing system and expose to room air.
3. Select "Start 21% O₂ Calibration" to start the calibration.
4. Reinstall O₂ sensor upon completion of calibration.

Directions for the 100% O₂ calibration:

1. The 100% cal can only be performed after a 21% cal.
2. With O₂ sensor installed in the breathing system, flow 100% O₂.
3. Select "Start 100% O₂ Calibration" to start the calibration.
4. Stop flow of 100% O₂ upon completion of calibration.

Each calibration may take up to 3 minutes to complete.

A/D Channel	Counts	Actual
O ₂	446	21.000 %

Calibration Status:

Start 21% O₂ Calibration
Start 100% O₂ Calibration
Go to Calibrations Menu

Remarks

Remove the O₂ sensor from the breathing system and expose it to room air. The displayed reading should be 21% ± 2% to pass the calibration requirements.

Place the sensor that passed the 21% test in the breathing system and expose it to 100% O₂.

If it displays readings higher or lower than required to pass, replace the sensor.

4.9.2 Zero Flow and Airway Sensors

The **Zero Flow and Airway Sensors** procedure

- zeros any offset in the amplifier for the airway pressure sensor
- determines the zero value for the inspiratory flow and expiratory flow measurement differential pressure transducers.

It does so by reading the A/D values for inspiratory flow, expiratory flow, and airway pressure when the flow sensors have been disconnected from the breathing system.

- If the calibration passes, the offset and zero values are stored in the EEPROM.
- If the A/D values are not within the correct tolerance the calibration fails.

If the calibration fails, the screen will display the reason for the failure.

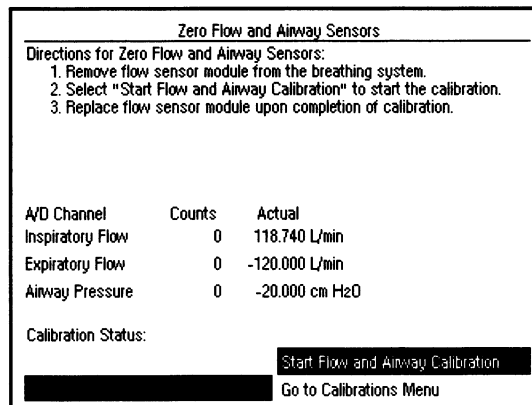

Remarks Ensure that the flow sensor module is disconnected from the breathing system.

“Fail” indicates a problem in the MIA/VMB (Inspiratory Flow and Expiratory Flow transducers) or the PEB/VEB (Airway Pressure transducer).

Check the transducer outputs using the “*Display A/D Channels*” menu (on “*Diagnostics*” menu).

If any of the transducers are out of tolerance:

- Follow Section 5.4.3, “Inaccurate Volume Ventilation Troubleshooting,” for issues with inspiratory and expiratory flow transducers.
- Replace the PEB/VEB assemblies, for issues with the airway pressure transducer.

4.9.3 Adjust Drive Gas Regulator

The **Adjust Drive Gas Regulator** procedure establishes the required flow rate through the drive gas regulator for proper calibration.

Adjust Drive Gas Regulator

Directions for Adjust Drive Gas Regulator:

1. Attach pressure test device to regulator pressure port.
2. Remove the bellows assembly and exhalation valve.
3. Select "Start Regulator Adjustment".
4. Adjust regulator until pressure test device reads 172 kPa (25 psi).
5. Select "Stop Regulator Adjustment" when regulator is adjusted.
6. Reassemble exhalation valve and bellows assembly when adjustment complete.

Start Regulator Adjustment
Go to Calibrations Menu

Remarks The drive gas regulator should provide a constant gas input pressure of 172 kPa (25 psi).

You can verify this pressure by attaching a pressure test device to the regulator pressure port (shown below) and adjusting the regulator to 172 ± 17.2 kPa (25 ± 0.25 psi).

Aestiva machine

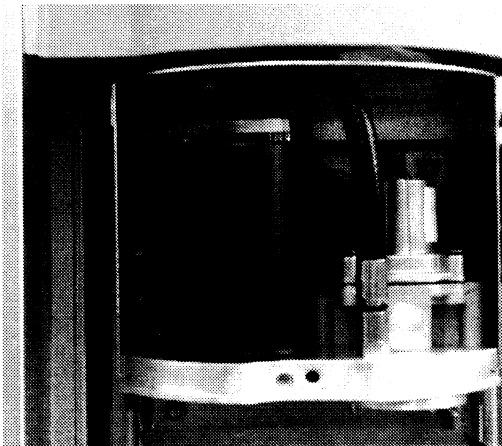

Aespire machine

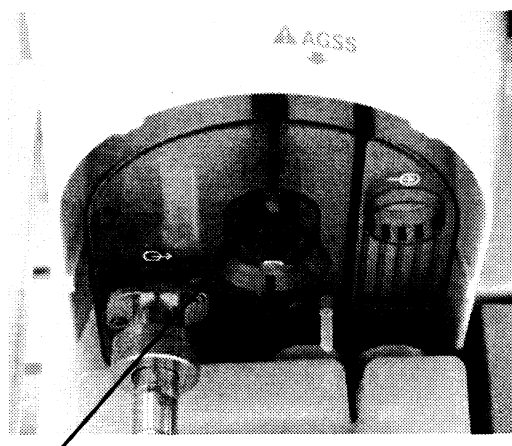

**Regulator
pressure
port**

4.9.4 Airway Sensor Span

The **Airway Sensor Span** procedure calculates a gain coefficient for the airway pressure transducer.

Airway Sensor Span		
Directions for Airway Sensor Span:		
1. Perform the "Zero Flow and Airway Sensors" calibration.		
2. Remove the bellows assembly and exhalation valve.		
3. Connect the calibrated flow orifice "Test Tool" to the manifold port.		
4. Connect tubing to the "Test Tool".		
5. Connect manometer to inspiratory flow port.		
6. Connect tubing from "Test Tool" to inspiratory flow port.		
7. Adjust airway pressure to 100 cm H ₂ O using "Set PEEP Valve".		
8. When pressure is 100 cm H ₂ O, select "Save Airway Sensor Span".		
9. Reassemble exhalation valve and bellows assembly when calibration complete.		
A/D Channel	Counts	Actual
Airway Pressure	878	0.400 cm H ₂ O
Calibration Status:		Set PEEP Valve Off
		Save Airway Sensor Span
		Go to Calibrations Menu

Calibration setup (Aestiva machine)

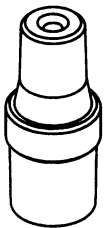

Calibrated Flow Orifice
1504-3005-000
for the Aestiva machine
(refer to Note in Section 8.2)

1. Disassemble the breathing system to the point where you can remove the exhalation valve.
 - **Remove:** flow sensor module, breathing circuit module, bag arm, open control panel, bellows assembly, main manifold, and exhalation valve.
2. Reassemble the breathing system leaving out the exhalation valve, bellows assembly, and bag arm.
 - **Replace:** main manifold, close control panel, breathing circuit module, and flow sensor module.
3. Attach a patient circuit tube to the Calibrated Flow Orifice test tool.
4. Insert the Calibrated Flow Orifice into the manifold (PEEP) port.
5. Connect a pressure sensing tee to the inspiratory flow patient connection.
6. Connect the open end of the patient circuit tube to the flow port of the pressure sensing tee.
7. Connect a manometer to the pressure sensing port of the tee connector.

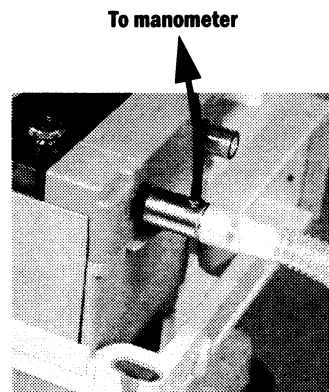
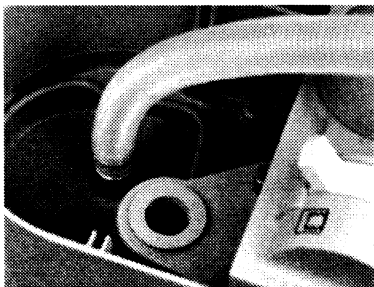

8. Refer to next page for calibration procedure

**Calibration setup
(Aespire machine)**

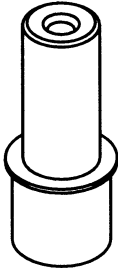

**Calibrated Flow Orifice
1504-3016-000
for the Aespire machine**

1. Remove the ABS breathing system from the machine.
2. Remove the Exhalation Valve.
3. Separate the Bellows Module from the Circuit Module.
4. Install the Circuit Module only.
5. Attach a patient circuit tube to the Calibrated Flow Orifice test tool.

Note: The Calibrated Flow Orifice for the Aespire has the same orifice size as the Calibrated Flow Orifice for the Aestiva; however, the Aestiva orifice has a larger outside dimension that does not fit through the Vent Engine cover plate. To use the Aestiva orifice with an Aespire machine, you must remove the cover plate to access the manifold port.

6. Insert the Calibrated Flow Orifice into the manifold (PEEP) port.
7. Connect a pressure sensing tee to the inspiratory flow patient connection.
8. Connect the open end of the patient circuit tube to the flow port of the pressure sensing tee.
9. Connect a manometer to the pressure sensing port of the tee connector.

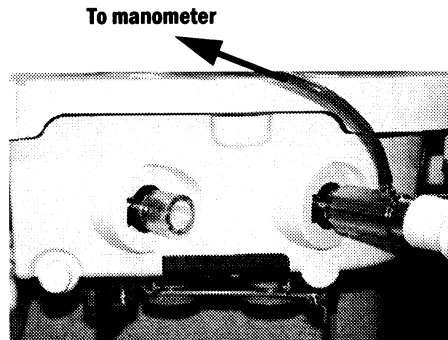
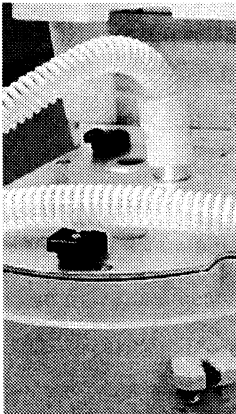

Calibration procedure

1. Select "Set PEEP Valve."
2. Adjust the PEEP Valve "counts" until the **manometer** reads 100 ± 0.3 cm H₂O (this will be at counts greater than 2500).
3. Press the control knob to activate the test at the selected PEEP Valve counts.
4. With the manometer at 100 cm H₂O, select "Save Airway Sensor Span."
5. If the calibration fails, the screen will display the reason for the failure.

Remarks

If the "Set PEEP Valve" value is set too high, pressure in the circuit may exceed 109 cm H₂O and trip the pressure limit switch. If this happens, lower the "Set PEEP Valve" value.

4.9.5 PEEP Valve Calibration

The **PEEP Valve Calibration** should be performed:

- when the machine is first put into service.
- at prescribed, planned maintenance intervals.
- after the pneumatic engine has been serviced.

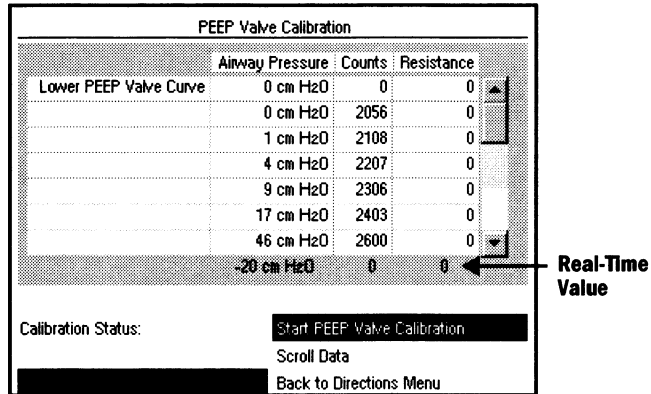
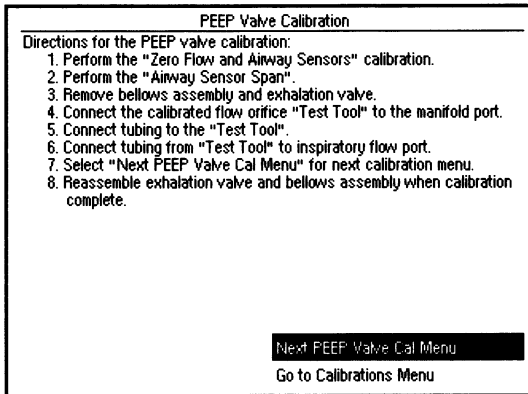

Calibration setup

After completing the "Airway Sensor Span" calibration in the previous section, remove the pressure sensing tee and connect the open end of the patient circuit tube directly to the inspiratory flow patient connection.

- If you are only performing the PEEP Valve calibration, connect the Calibrated Flow Orifice as detailed in the "Airway Sensor Span" setup. Then, connect the open end of the patient circuit tube directly to the inspiratory flow patient connection.

Calibration procedure

1. To enter the calibration menu, select "Next PEEP Valve Cal Menu".
2. Establish drive gas for the ventilator.
3. Set all flow controls to minimum.
4. To start calibration, select "Start PEEP Valve Calibration".

Note: This calibration procedure may take up to 20 minutes.

The calibration status and progression bar are displayed at the bottom of the screen.

If the calibration fails, the screen will display the reason for the failure. (Ensure that the test tubing is leak free.)

Remarks

The calibration routine opens the PEEP valve stepwise and reads the resulting airway pressure. The accumulated values represent the output linearity curve for this particular PEEP valve. The accumulated data include:

- Lower PEEP Valve Curve
- Upper PEEP Valve Curve
- PEEP Temperature Comp
- PEEP Nominal Resistance

The data is stored in EEPROM and is used during normal operation to compensate for the individual valves output characteristics.

Scroll Data

To view the stored data, select "Scroll Data".

4.9.6 Inspiratory Valve Calibration

The **Inspiratory Valve Calibration** should be performed:

- when the machine is first put into service.
- at prescribed, planned maintenance intervals.
- after the pneumatic engine has been serviced.

Inspiratory Valve Calibration

Directions for the Inspiratory valve calibration:

1. Perform the "Zero Flow and Airway Sensors" calibration.
2. Perform the "Airway Sensor Span".
3. Connect tubing to inspiratory flow port.
4. Connect calibrated flow orifice "Test Tool" to tubing.
5. Remove bellows housing and remove bellows.
6. Replace bellows housing.
7. Set Bag/Vent switch to Vent position.
8. Adjust fresh gas flow so Airway Pressure is 1.05 cm H₂O.
9. Select "Next Inspiratory Valve Cal Menu" for next calibration menu.
10. Reassemble bellows when calibration complete.

A/D Channel	Counts	Actual
Airway Pressure	0	-20.000 cm H ₂ O

Next Inspiratory Valve Cal Menu
 Go to Calibrations Menu

Calibration setup

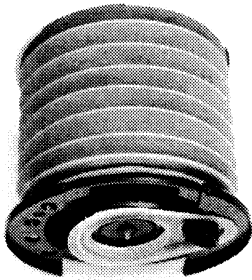

1. Remove the bellows and pressure relief valve (pop-off) from the bellows assembly.
 - Remove the bellow housing.
 - Remove the bellows and bellows mounting rim as an assembly.
 - Remove the pressure relief valve.
 - Replace the bellows housing.
 - **Note:** If you have just completed the PEEP Valve Calibration, remove these parts from the bellows assembly and then reassemble the breathing system.
2. Attach a patient circuit tube to the Calibrated Flow Orifice test tool.
3. Connect the open end of the patient circuit tube to the inspiratory flow patient connection.
4. Set the Bag/Vent switch to Vent.
5. Establish drive gas for the ventilator.
6. Adjust fresh gas flow so the actual Airway Pressure reads 1.05 cm H₂O.

Calibration procedure

1. To enter the calibration menu, select "Next Inspiratory Valve Cal Menu".
2. To start calibration, select "Start Inspiratory Valve Calibration".

Note: This calibration procedure may take up to 5 minutes.

The calibration status and progression bar are displayed at the bottom of the screen.

If the calibration fails, the screen will display the reason for the failure.

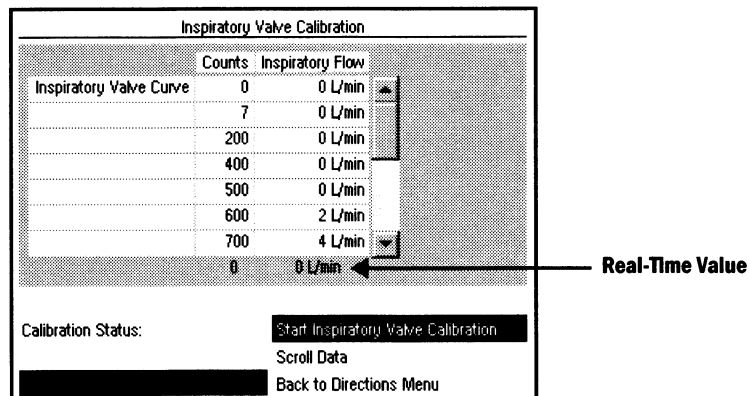
**Remarks**

With the bellows removed from the bellows assembly, the output from the inspiratory valve is routed through the breathing system to the Airway Pressure transducer. The calibrated orifice provides a precise restriction to the flow.

The calibration routine opens the Inspiratory valve stepwise and reads the resulting pressure at the airway pressure transducer. The inspiratory flow displayed on the screen for this test is a calculation of the pressure measured by the airway pressure transducer times a constant (based on the size of the orifice in the test tool).

The accumulated values represent the output linearity curve for this particular Inspiratory valve.

The data is stored in EEPROM and is used during normal operation to compensate for the individual valves output characteristics.

Scroll Data

To view the stored data, select "Scroll Data".

4.9.7 Pressure Sensitivity

The **Pressure Sensitivity** calibration calculates correction factors for common mode pressure sensitivity of the differential pressure transducers. The pressure transducers must be calibrated whenever the MIA/VMB or the Control Board is replaced.

This pressure sensitivity calibration is not an automated calibration. Follow the prompts on the screen to complete the calibration. The routine calculates the pressure sensitivity at four different pressures (10, 20, 40, and 60 cm H₂O) and extrapolates the fifth pressure point (70 cm H₂O). It uses these five pressure points along with the zero offsets to find the pressure sensitivity.

- If the calibration passed, the five pressure sensitivity points are stored in the EEPROM.
- If the calculations for the pressure sensitivity are not within the correct tolerance, the calibration fails.

If the calibration fails, the screen will display the reason for the failure.

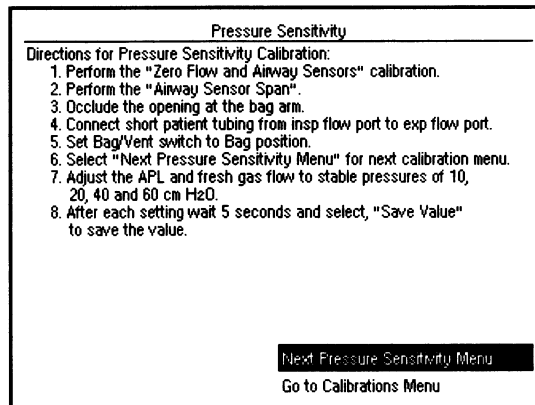

Calibration procedure

1. Perform the "Zero Flow and Airway Sensors" calibration.
2. Perform the "Airway Sensor Span".
3. Occlude the opening at the bag arm
4. Connect short patient tubing from the inspiratory flow patient connection to the expiratory flow patient connection.
5. Set the Bag /Vent switch to the Bag position.
6. Select "Next Pressure Sensitivity Menu" for the next calibration menu.

Pressure Sensitivity		
Pressure Sensitivity		Airway Pressure
Insp Flow @ 10 cm H ₂ O:	0	0 cm H ₂ O
Insp Flow @ 20 cm H ₂ O:	0	0 cm H ₂ O
Insp Flow @ 40 cm H ₂ O:	0	0 cm H ₂ O
Insp Flow @ 60 cm H ₂ O:	0	0 cm H ₂ O
Insp Flow @ 70 cm H ₂ O:	0	0 cm H ₂ O
Exp Flow @ 10 cm H ₂ O:	0	0 cm H ₂ O
Exp Flow @ 20 cm H ₂ O:	0	0 cm H ₂ O
		-20 cm H ₂ O



Save Value
 Start Pressure Sensitivity Cal
 Scroll Data
 Back to Directions Menu

Real-Time Value

7. To start calibration select "Start Pressure Sensitivity Cal".

- Adjust the APL and fresh gas flow until the real-time pressure reads a **stable 10 cm H₂O** – after 5 seconds, select "Save Value".
- Adjust the APL and fresh gas flow until the real-time pressure reads a **stable 20 cm H₂O** – after 5 seconds, select "Save Value".
- Adjust the APL and fresh gas flow until the real-time pressure reads a **stable 40 cm H₂O** – after 5 seconds, select "Save Value".
- Adjust the APL and fresh gas flow until the real-time pressure reads a **stable 60 cm H₂O** – after 5 seconds, select "Save Value".



4.9.8 Service Calibrations Required

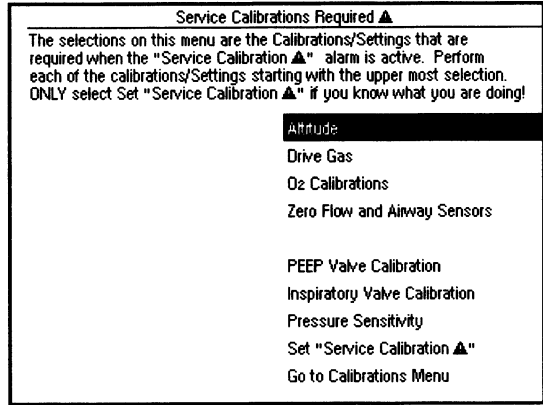

The **Service Calibrations Required**  menu displays which setting or calibration must be performed when the “Service Calibration ” alarm appears in normal operation. After the setting or calibration is properly completed, the text for that setting or calibration will be removed.



Remarks

The normal operation “Service Calibration ” alarm message is only removed when all the required settings or calibrations are completed.

The **Set “Service Calibration ”** menu item is used by the factory to activate the “Service Calibration ” alarm and require that all settings and calibrations be performed when the machine is set up for operation at its permanent location.

You can reset the “Service Calibration ” alarm in the field by selecting “Yes” when the following warning appears after selecting the “Set Service Calibration ” menu item.

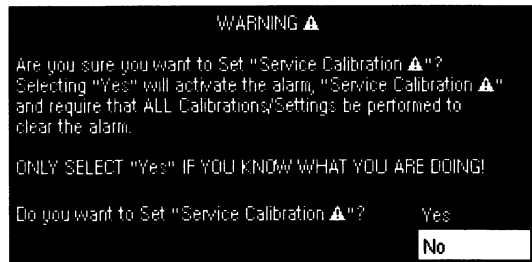

4.10 Diagnostic Tests/Tools

The **Diagnostic Tests/Tools** menu includes a selection of items that look at individual subsystems of the 7100 Ventilator.

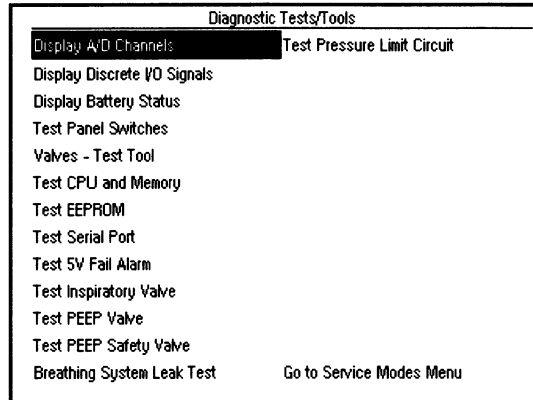

4.10.1 Display A/D Channels

The **Display A/D Channels** menu displays the measured values for each of the A/D channels.

Display A/D Channels			Page 1 of 2
A/D Channel	Counts	Actual	Range
Inspiratory Flow	1997	1.736 L/min	-120 to 120 L/min
Expiratory Flow	2039	-0.028 L/min	-120 to 120 L/min
Airway Pressure	879	0.440 cm H ₂ O	-20 to 120 cm H ₂ O
O ₂	499	24.000 %	0 to 100%
Flow Valve Volt	1	0.002 Volts	0 to 6.140 Volts
PEEP Valve Volt	0	0.000 Volts	0 to 6.140 Volts
Flow DAC Feedback	0	0.000 Volts	0 to 4.095 Volts
PEEP DAC Feedback	0	0.000 Volts	0 to 4.095 Volts

Go to Diagnostic Tests/Tools Menu

Display A/D Channels			Page 2 of 2
A/D Channel	Counts	Actual	Range
1.225 Volt Ref	1224	1.224 Volts	1.214 to 1.235 Volts
+12V 10VA Supply	2066	12.080 Volts	10.5 to 13.5 Volts
+12V Analog Supply	2044	11.992 Volts	10.5 to 13.5 Volts
-12V Analog Supply	404	-12.071 Volts	-10.2 to -13.86 Volts
Battery Voltage	3365	6.733 Volts	0 to 8.220 Volts
Battery Current	1012	0.050 Amps	-2 to 6.190 Amps

Go to Diagnostic Tests/Tools Menu

Remarks The **Counts** and **Actual** values are typical for a calibrated system with baseline inputs to the various sensors.

Refer to the following table for additional details for each of the displayed channels.

A/D Channel	Counts ¹ (range)	Actual ²	Range	Comments
Inspiratory Flow	2050 (1800-2300)	0.000 L/min	-120 to 120 L/min	Zero Offset Reading (nominal 2050 Counts) Increased flow = more counts/more positive
Expiratory Flow	2050 (1800-2300)	0.000 L/min	-120 to 120 L/min	Zero Offset Reading (nominal 2050 Counts) Increased flow = less counts/more negative
Airway Pressure	800 (550-1050)	0.000 cmH2O	-20 to 120 cmH2O	Zero Offset Reading (nominal 800 Counts)
O ₂	377 (0-4095)	21.000%	0 to 100%	Count weight and limits are determined during O ₂ calibration
Flow Valve Volt	0 (0-4095)	0.000 Volts	0 to 6.140 Volts	
PEEP Valve Volt	0 (0-4095)	0.000 Volts	0 to 6.140 Volts	
Flow DAC Feedback	0 (0-4095)	0.000 Volts	0 to 4.095 Volts	
PEEP DAC Feedback	0 (0-4095)	0.000 Volts	0 to 4.095 Volts	

1.225 Volt Ref	1.225 (1214-1235)	1.225 Volts	1.214 to 1.235 Volts	
+12V 10VA Supply	2041	11.975 Volts	10.5 to 13.5 Volts	12V-10VA Test Out-of-Range (Minimum Shutdown)
+12V Analog Supply	2050	12.027 Volts	10.5 to 13.5 Volts	+12V Analog Out-of-Range (Minimum Shutdown)
-12V Analog Supply	396	-12.071 Volts	-10.2 to -13.86 Volts	-12V Analog Out-of-Range (Minimum Shutdown)
Battery Voltage	3609	7.215 Volts	0 to 8.220 Volts	> 8 Volts (10 sec) = Battery Failure High < 5.65 Volts = Low Battery Voltage < 2 Volts = Battery Failure Low
Battery Current	997	-0.008 Amps	-2 to 6.190 Amps	< -750 mA = Battery Charger Fail -330 to -700 mA (1 min) = Battery charging Δ >600 mA (10 sec)= On Battery-Power OK? >6 Amps (10 sec) = Battery Current High

Notes:

1. The **Counts** column shows typical digital counts from the computer with the expected (**range**) shown in parenthesis.
2. The **Actual** column shows current values in real time with inputs in their baseline state.

4.10.2 Display Discrete I/O Signals

The **Display Discrete I/O Signals** menu displays discrete binary signals associated with machine switch positions.

There are several types of switches in the machine:

- some switches are mechanically operated,
- some switches are pneumatically operated,
- some switches are electronic,
- some “switches” are software derived.

Signal	Status	Signal	Status
ACGO Switch	Aux CGO	O ₂ Flush	Off
CO ₂ Bypass	On	Bag/Vent Status	Bag
Canister Status	Open	Supply Pressure	Pressure
Control Panel Cover	Open	Safety Valve Circuit	Pass
O ₂ Sensor Status	Connected	VBUS Voltage	Pass
Breathing Circuit SW1	On		
Breathing Circuit SW2	On		
Breathing Circuit SW3	On		
Pressure Limit Status	On		
O ₂ Supply Pressure	Pressure		

Go to Diagnostic Tests/Tools Menu

Mechanical switches

- ACGO Switch – Vent or Aux CGO (machines equipped with ACGO)
- CO₂ Bypass – Off or On (Off by default in Aespire machines)
- Canister Status – Closed or Open (Closed by default in Aespire machines)
- Control Panel Cover – Closed or Open (refers to removal of ABS on Aespire machines)
- Bag/Vent Status – Vent or Bag

Pneumatic switches

- O₂ Supply Pressure – Pressure or No Pressure
- O₂ Flush – Off or On
- Supply Pressure – Pressure or Low Pressure (drive gas)

Electronic switches

- O₂ Sensor Status – Connected or Disconnected
- Circuit module ID

Module	Switch One	Switch Two	Switch Three
Circle	Off	Off	On
Bain/Mapleson D	On	Off	Off
(no module)	On	On	On

(Hard-wired to indicate Circle Module on Aespire machines)

- Pressure Limit Status – Off or On (if Paw exceeds 108 cm H₂O)

Software “switches”

- Safety Valve Circuit – Pass or Fail
- VBUS Voltage – Pass or Fail

4.10.3 Display Battery Status

The **Display Battery Status** menu displays the battery charge status.

Display Battery Status			
Battery Status: Battery Charged			
A/D Channel	Counts	Actual	Range
Battery Voltage	3372	6.729 Volts	0 to 8.220 Volts
Battery Current	1017	0.036 Amps	-2 to 6.190 Amps
Go to Diagnostic Tests/Tools Menu			

Battery Status (on line power)

“Battery Charged” – If none of the following conditions are in effect.

“Battery Charging \triangle ” – Battery Current = -330 to -700 mA

“Battery Failure Low” – Battery Voltage <2 Volts

“Battery Failure High” – Battery Voltage >8 Volts

“Battery Current High” – Battery Current >6 Amps

“Battery Charger Fail” – Battery Current < -750 mA

Battery Status (on battery power)

“On Battery-Power OK?” – System is running on battery.

“Low Battery Voltage” – Battery Voltage <5.65 Volts

Remarks

While the battery is charging, the battery current is displayed as negative current. If the battery has been on charge for a long time (8 hours minimum) and you do not get a “Battery Charged” display:

- The battery has failed and you should replace it.

When the battery is discharging, the battery current is displayed as positive current. Disconnect the power cord and observe the discharge current.

- A good, fully-charged battery should maintain a steady discharge current (for at least 30 minutes under normal operation).
- If the discharge current and battery voltage drops off quickly, the battery has failed and you should replace it.

\triangle Warning

Depending on the battery condition and the ventilator settings, continued operation of the mechanical ventilation may result in sudden shut down.

4.10.4 Test Panel Switches

In the **Test Panel Switches** menu the software is set up to receive keyboard button presses and rotary encoder turns.

Press each button on the panel and the control knob.

- When a button is pressed, the icon on the screen next to the button should be highlighted and filled with a checkmark.
- When the button is released, the button icon should be reverse-highlighted.

After testing all the buttons and the control knob, select "Test Encoder Knob Turn" to test the encoder.

As you turn the encoder knob, verify that:

- each click of the encoder in the clockwise direction increments the clockwise total.
- each click of the encoder in the counterclockwise direction increments the counterclockwise total.

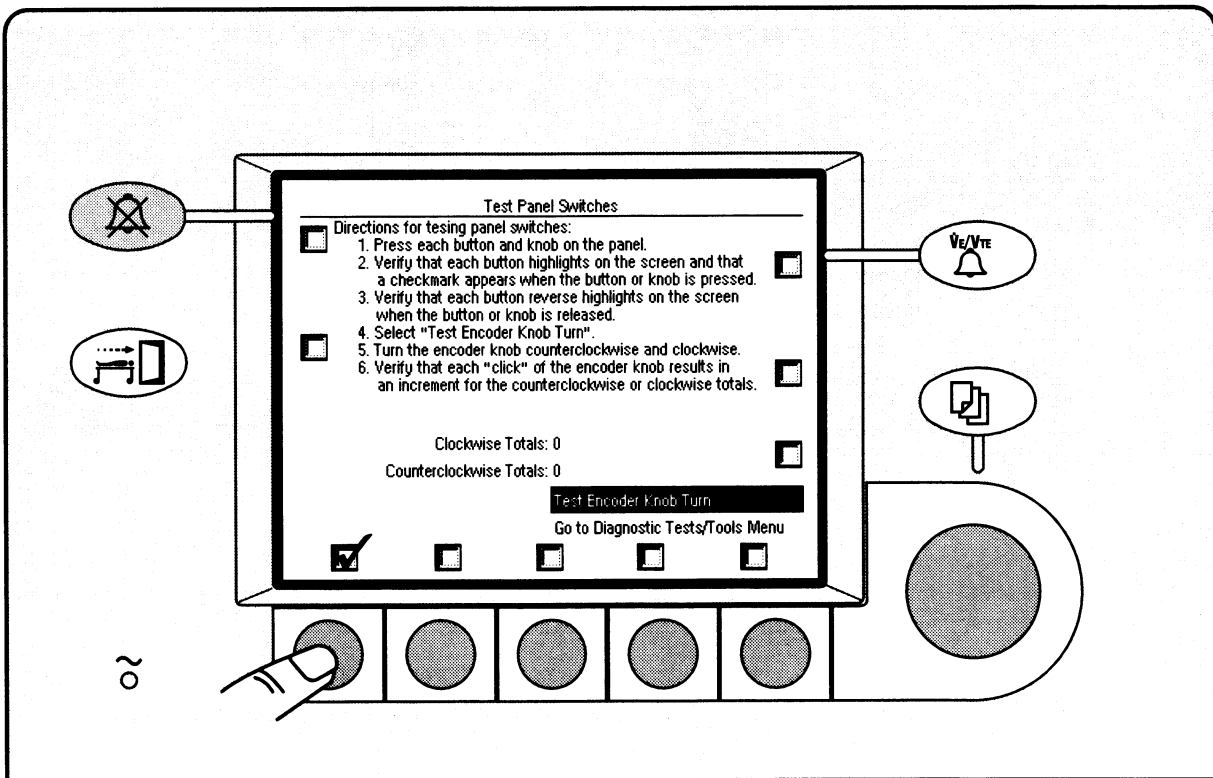

Remarks If any of the select buttons test fails, replace the front panel keyboard assembly.

If the encoder knob test fails, replace the rotary encoder assembly.

4.10.5 Valves - Test Tool

The **Valves - Test Tool** menu allows you to manually control the Inspiratory Valve, the PEEP Valve, and the PEEP Safety Valve, and observe key pressure and flow measurements on the same screen.

This menu is mainly used to test the drive gas circuit or to supply drive gas flow for several tests:

- It is used to test the mechanical overpressure valve as detailed in section 6.4 of this manual, “MOPV pressure relief valve test.”
- It is used to check primary regulators as detailed in section 6 of the anesthesia machine Technical Reference Manual.

Valves - Test Tool		
Directions for the Valves - Test Tool: 1. Refer to Service Manual for a description of the various tests.		
A/D Channel	Counts	Actual
Inspiratory Flow	1986	2.278 L/min
Expiratory Flow	2039	-0.055 L/min
Airway Pressure	878	0.400 cm H ₂ O
Flow Valve Volt	0	0.000 Volts
PEEP Valve Volt	0	0.000 Volts
Set Inspiratory Valve Off 0 counts Set PEEP Valve Off 0 counts Set PEEP Safety Valve Closed Go to Diagnostic Tests/Tools Menu		

Set Inspiratory Valve

The flow through the Inspiratory Valve can be set:

- from **Off to 70 L/min** in 0.25 L/min increments.

Set PEEP Valve

The PEEP Valve can be set:

- from **Off to 100 cm H₂O** in 0.5 cm H₂O increments.

Set PEEP Safety Valve

The PEEP Safety Valve can be set:

- **Closed or Open**

Remarks

When setting the Inspiratory Valve or the PEEP Valve:

- Turn the encoder clockwise to increase the values.
- Turn the encoder counterclockwise to begin at the maximum and to decrease the values.

4.10.6 Test CPU and Memory

When you start the **CPU and Memory Tests**, the procedure cycles through the CPU, RAM, Display RAM, and ROM tests until you stop the tests. The procedure keeps track of how many times each test passed or failed.

If you note that any of these tests have failed, replace the control board.

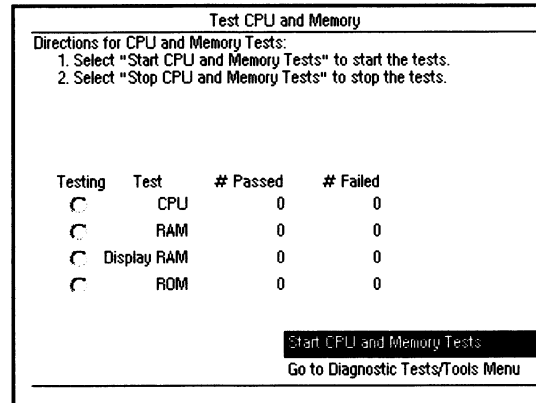

CPU Test The software tests the CPU integer instructions as well as the CPU register(s). If this test fails, the CPU did not perform an integer instruction correctly, or the CPU register(s) have failed.

RAM Test The software tests all of the external RAM memory with a walking bit pattern test. It writes a certain bit pattern to a block of memory and then reads that block of memory. If the bit pattern that it wrote is not the same bit pattern that it reads back the test fails.

Display RAM Test The software tests all of the display RAM memory via a walking bit pattern test. It writes a certain bit pattern to a block of memory and then reads that block of memory. If the bit pattern that was written is not the same bit pattern that it reads back the test fails.

ROM Test The software tests the Flash ROM via a CRC check (Cyclic Redundancy Check). A CRC value has been calculated for the Flash ROM memory and this value is stored in the Flash ROM. This test recalculates the CRC for the Flash ROM and compares it to the value stored in Flash ROM. If the value that was calculated does not equal the value that was stored in Flash ROM, the test will fail.

4.10.7 Test EEPROM

When you start the **EEPROM Test**, the procedure performs the test once and notes whether the test passed or failed.

If the EEPROM test fails, replace the control board.

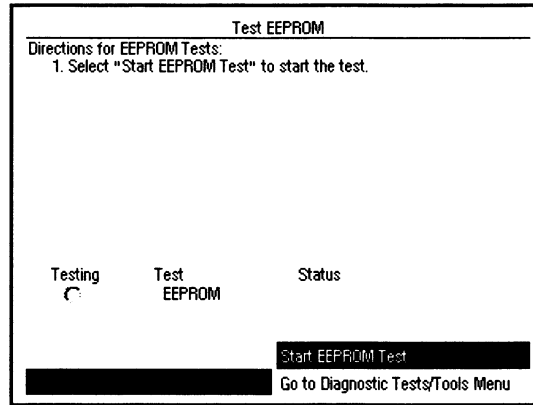

EEPROM Test

The software tests all of the EEPROM memory via a bit pattern test. It writes a certain pattern to a block of memory and then reads that block of memory. If the bit pattern that was written is not the same as the bit pattern read back, the test fails.

4.10.8 Test Serial Port

The **Test Serial Port** menu includes directions for two tests.

- **External Serial Port Testing:** The external test requires that you jumper pins 6 and 13 of the serial connector.

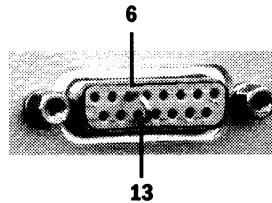

- **Internal Serial Port Testing:** The internal test does not require any setup; it only tests serial port related components on the control board.

Each test routine sets up the serial port circuits so transmit data is echoed directly back to the receive circuits. The test fails if the data sent out is not equal to the data received.

Test Serial Port

Directions for External Serial Port Testing:

1. Disconnect any monitor that may be connected to the serial port.
2. Jumper pins 6 and 13 on the serial port.
3. Select "Start External Serial Port Test" to start the testing.
4. Select "Stop External Serial Port Test" to stop the testing.
5. Remove jumper from serial port and reconnect any monitor to the serial port that may have been disconnected.

Directions for Internal Serial Port Testing:

1. Select "Start Internal Serial Port Test" to start the testing.
2. Select "Stop Internal Serial Port Test" to stop the testing.

Testing	Test	# Passed	# Failed
<input type="radio"/>	External	0	0
<input type="radio"/>	Internal	0	0

Remarks If only the internal test fails, replace the control board.

If both tests fail:

- Check the harness connections between the control board and the Serial board (SAB/SICB).
- Check the ribbon cable between the SAB and the external connector.
- Replace the SAB/SCIB.

**4.10.9
Test 5V Fail Alarm**

The 5-Volt supply (VDD) is derived in the power section of the control board. It is used to power the digital circuits throughout the ventilator. If the 5-Volt supply fails, the ventilator will sound a continuous alarm tone when the system switch is turned on.

To **Test the 5V Fail Alarm**, follow the directions on the screen.

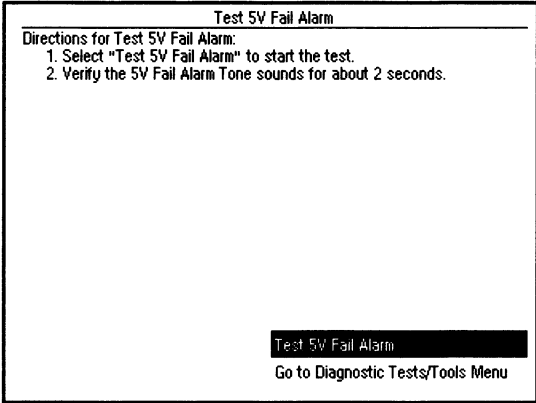

Remarks If the alarm tone does not sound, replace the control board.

4.10.10 Test Inspiratory Valve

This test only checks the control circuit for the Inspiratory Valve. Since it does not look at the output of the Inspiratory Valve, you do not have to have an active drive gas supply.

To **Test the Inspiratory Valve** the software opens the inspiratory valve in increments until the flow valve is completely open.

- At each of the settings of the inspiratory valve the A/D channel for Flow DAC Feedback is recorded.
- If the A/D for the Flow DAC Feedback is not within the correct tolerance the test fails.

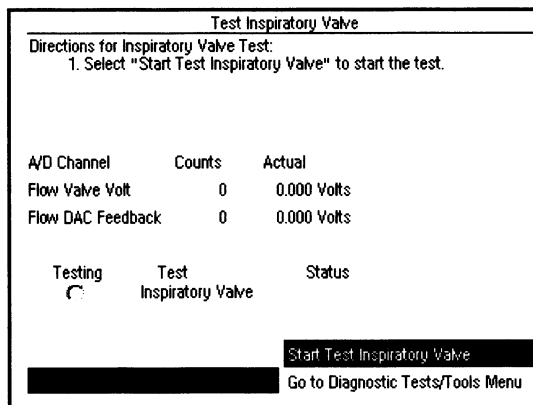

Remarks A failure can be caused either by the control circuit or a flow valve malfunction.

To check the control circuit,

1. Go to the "Valves - Test Tool" menu.

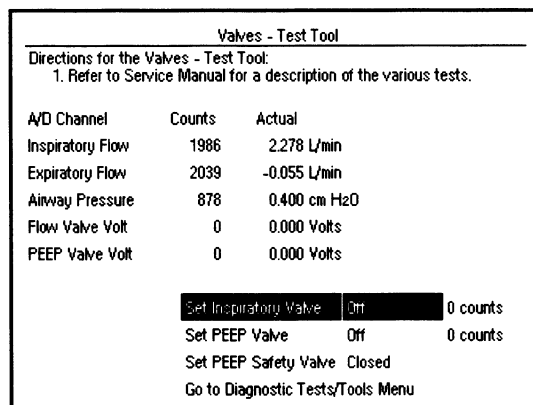

2. Set the Inspiratory Valve to 0.25 L/min. The "Flow Valve Volt" reading should increase slightly.
3. If the reading jumps high (~ 6 Volts), the control circuit for the Inspiratory Valve is open or the Inspiratory Valve is defective.
4. Measure the resistance between the leads at the unplugged Inspiratory Valve connector. A multimeter should read 1.5 ±0.15 ohms.

4.10.11 Test PEEP Valve

This test only checks the control circuit for the PEEP Valve. Since it does not look at the output of the PEEP Valve, you do not have to have an active drive gas supply.

To **Test the PEEP Valve** the software opens the PEEP valve in increments until the PEEP valve is completely open.

- At each of the settings of the PEEP valve the A/D channel for PEEP DAC Feedback is recorded.
- If the A/D for the Flow DAC Feedback is not within the correct tolerance the test fails.

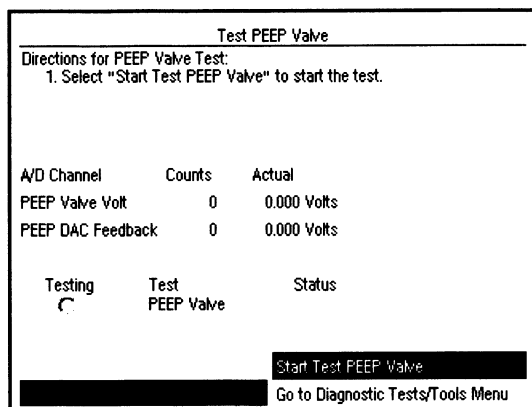

Remarks

A failure can be caused either by the control circuit or a PEEP Valve malfunction.

To check the control circuit,

- Go to the “Valves - Test Tool” menu.

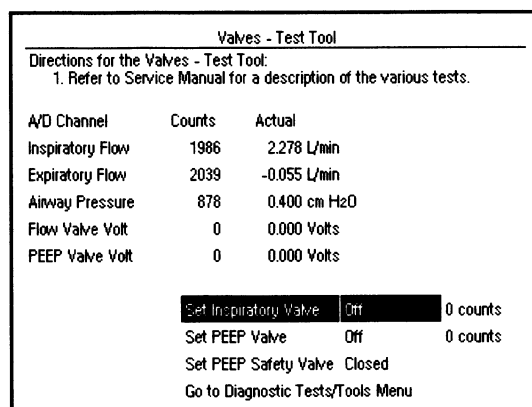

- With the PEEP Valve set to “Off”, the “PEEP Valve Volts” should read near 0.000 Volts.
- If the reading is high (~ 6 Volts), the control circuit for the PEEP Valve is open or the PEEP Valve is defective.
- Measure the resistance between the open terminals of the PEEP Valve (blue). A multimeter should read 10 ± 1 ohm.

4.10.12 Test PEEP Safety Valve

This test requires an active drive gas supply.

To **Test the PEEP Safety Valve** the software opens the PEEP Safety Valve and checks the output of the Supply Pressure Switch.

- If the Supply Pressure Switch detects pressure, the PEEP Safety Valve test passes.
- If the Supply Pressure Switch does not detect pressure, the PEEP Safety Valve test fails.

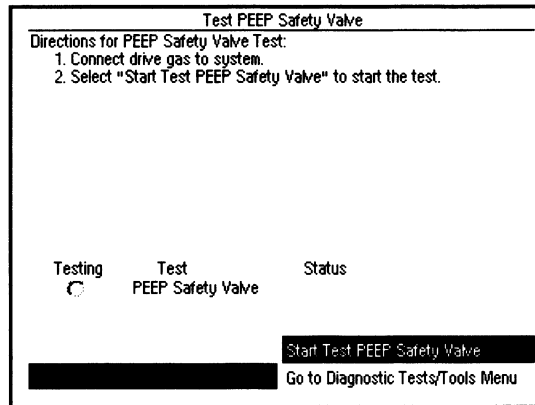

Remarks

A failure can be caused either by the control circuit or a PEEP Safety Valve malfunction.

To check the control circuit,

1. Go to the “Valves - Test Tool” menu.

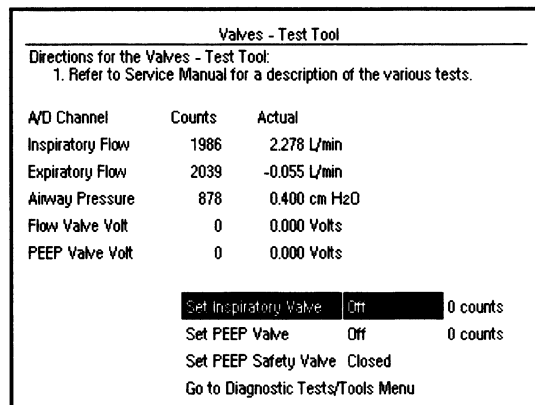

2. Set the PEEP Safety Valve to “Open” and listen for a “click” in the area of the pneumatic engine.
3. If you do not hear a “click” each time the PEEP Safety Valve is opened, the control circuit to the PEEP Safety Valve is open or the PEEP Safety Valve is defective.
4. Measure the resistance between the open terminals of the PEEP Safety Valve (white). A multimeter should read 10 ±1 ohm.

4.10.13 Breathing System Leak Test

You can estimate how much of a leak there is in the ventilator portion of the breathing system by closing the patient circuit, inflating the bellows, and observing how quickly they fall on their own weight (part of machine checkout procedure).

The **Breathing System Leak Test** allows you to more precisely test the ventilator portion of the breathing system for leaks.

Breathing System Leak Test

Directions for Breathing System Leak Test:

1. Set Bag/Vent switch to Vent position.
2. Set fresh gas flow to minimum.
3. Open patient "Y" connection to atmosphere.
4. Select "Start Leak Test" to start the test.
5. Connect open end of patient "Y" to plug on breathing system handle.
6. Slowly increase fresh gas flow until Pressure Gauge reads 30 cm H₂O.
7. Leak rate is the fresh gas flow needed to maintain 30 cm H₂O.

Start Leak Test
 Go to Diagnostic Tests/Tools Menu

Note regarding plug:

On an Aespire machine the plug is located on the side of the ABS.

Remarks By using the patient circuit to establish a closed loop, you can measure the leak rate.

- The leak rate is the fresh gas flow needed to maintain 30 cm H₂O.
- The system should have a leak rate < 200 mL/min.

4.10.14 Test Pressure Limit Circuit

The airway pressure limit circuit should trip at approximately 109 cm H₂O.

The **Test Pressure Limit Circuit** routine:

- establishes a closed patient airway circuit,
- increments the pressure in the airway circuit,
- observes the output of the airway pressure transducer,
- notes at what pressure the “pressure limit circuit” trips.

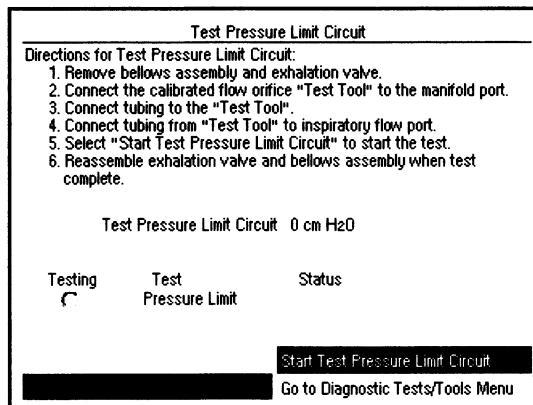

Test setup (Aestiva machine)

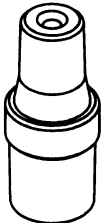

**Calibrated Flow Orifice
1504-3005-000
for the Aestiva machine
(refer to Note in Section 8.2)**

1. Disassemble the breathing system to the point where you can remove the exhalation valve.
 - **Remove:** flow sensor module, breathing circuit module, bag arm, open control panel, bellows assembly, main manifold, and exhalation valve.
2. Reassemble the breathing system leaving out the exhalation valve, bellows assembly, and bag arm.
 - **Replace:** main manifold, close control panel, breathing circuit module, and flow sensor module.
3. Set the Bag/Vent switch to Vent.
4. Attach a patient circuit tube to the Calibrated Flow Orifice test tool.
5. Insert the Calibrated Flow Orifice into the manifold (PEEP) port.
6. Connect the open end of the patient circuit tube to the inspiratory flow patient connection.

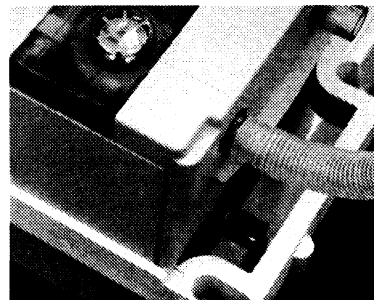
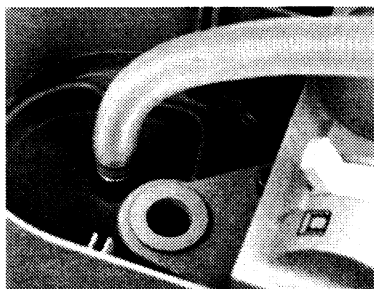

7. Refer to next page for test procedure

**Test setup
(Aespire machine)**

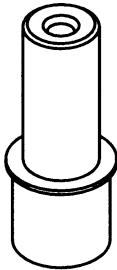

**Calibrated Flow Orifice
1504-3016-000
for the Aespire machine**

1. Remove the ABS breathing system from the machine.
2. Remove the Exhalation Valve.
3. Separate the Bellows Module from the Circuit Module.
4. Install the Circuit Module only.
5. Set the Bag/Vent switch to Vent.
6. Attach a patient circuit tube to the Calibrated Flow Orifice test tool.

Note: The Calibrated Flow Orifice for the Aespire has the same orifice size as the Calibrated Flow Orifice for the Aestiva; however, the Aestiva orifice has a larger outside dimension that does not fit through the Vent Engine cover plate. To use the Aestiva orifice with an Aespire machine, you must remove the cover plate to access the manifold port.

7. Insert the Calibrated Flow Orifice into the manifold (PEEP) port.
8. Connect the open end of the patient circuit tube to the inspiratory flow patient connection.

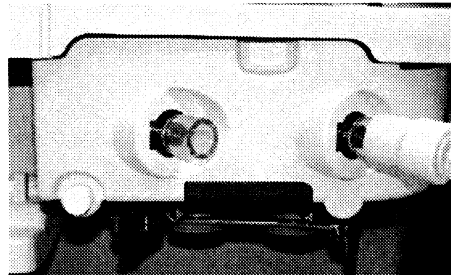
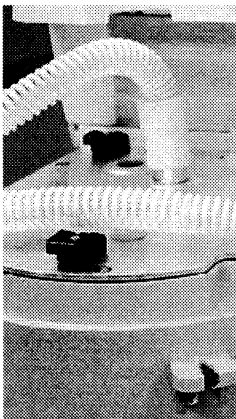

Test Procedure

1. Select "Start Test Pressure Limit Circuit" to start the test.
If the "Test Pressure Limit Circuit" trip point is approximately 109 cm H₂O, the test passes.

4.11 Upgrade Options

The **Upgrade Options** menu shows what features are currently available in the ventilator's software.

The ventilator can be upgraded to include additional features by entering the upgrade "Key Code" that the customer has purchased.

The screenshot shows a menu titled "Upgrade Options" with the following content:

- Control Board ID: 794
- Current Key: 1 5 7 2 Q A 1
- Upgrade Options Installed:
 - Pressure Mode
 - Oz Monitoring
 - Volume Monitoring
 - Volume Compensation
 - Pressure Waveform
- Enter Key to Install Upgrade(s):
 - 0 0 0 0 0 0 0 0
- Buttons: "Confirm Key And Upgrade" and "Go to Service Modes Menu"

Remarks Select each "digit" in the "Enter Key to Install Upgrade(s):" field and rotate the control knob to select the corresponding digit in the Key Code.

When you have entered all the digits, select "Confirm Key And Upgrade."

After verifying the Key Code match to the Control Board ID, the menu will display the newly installed features.

Note If the ventilator "Key Code" is changed, the new code should be recorded on the display module rear panel label.

5 Troubleshooting

⚠ WARNING Post-Service Checkout is required after you complete this section. You must perform Section “3/Post-Service Checkout” after performing any maintenance, service or repair. Failure to do so may result in patient injury.

In this section	5.1 Troubleshooting instructions	5-2
	5.2 Troubleshooting guide	5-2
	5.3 Alarm and Error messages	5-4
	5.4 Troubleshooting Flowcharts	5-15
	5.4.1 Ventilator assessment process	5-15
	5.4.2 No display troubleshooting	5-16
	5.4.3 Inaccurate volume ventilation troubleshooting	5-17
	5.4.5.B VMB board evaluation (Aespire machine)	5-19
	5.4.6 No ventilation troubleshooting	5-20
	5.4.7 High intrinsic PEEP troubleshooting	5-21

5.1 Troubleshooting instructions

Some ventilator problems may not generate any ventilator messages, even though the ventilator may not be functioning correctly:

- Refer to section 5.2 Troubleshooting guide.

For ventilator problems that result in an Alarm or Error message:

- Refer to section 5.3 Alarm and Error messages.

To help isolate a problem:

- Refer to section 5.4 Troubleshooting Flowcharts.

5.2 Troubleshooting guide

Symptom	Probable cause	Action
<ul style="list-style-type: none"> Continuous alarm sounds whenever system switch is turned On – 5V Fall Alarm 	1. Failure in power section of Control Board. The Control Board includes a hardware generated alarm that sounds continuously if the 5 volt supply fails.	1. Replace Control Board.

Symptom	Probable cause	Action
<ul style="list-style-type: none"> AC LED not lit (Power cord plugged into live receptacle; AC Inlet circuit breaker On) (The problem is most likely in the +6V supply or in the LED circuit.)	1. Blown fuses in Control Module's AC receptacle 2. Universal power supply 3. Front panel keyboard (LED is part of it) 4. Control board	1. Check/replace fuses. 2. Check power supply output. 3. Check ribbon cable connection; replace front panel keyboard. 4. +6V-----R11----- to LED; replace Control Board.
The LED is powered by the +6V supply from the universal power supply. Turn system switch to On. If ventilator operates from the backup battery, check 1 and 2. If ventilator operates from line power, check 3 and 4.		

Symptom	Probable cause	Action
<ul style="list-style-type: none"> Nothing happens when System switch is turned On (The problem is most likely somewhere between the system switch and the control board.)	1. Cable from J11 of Control Board to SAB/SICB. 2. Cable from System Switch to SAB/SICB. 3. Serial Adapter Board (SAB -Aestiva) Serial Isolation Connector Board (SICB - Aespire)	1. Check/jumper cable connection; replace cable. 2. Check cable connection; replace cable. 3. Replace SAB/SICB.
Turning the system switch to On should pull the <i>Rem_On</i> signal low on the control board. The above actions verifies the integrity of the <i>Rem_On</i> signal path. First, jumper pins 8 and 15 of J11 on control board to verify that the control board itself is OK.		

Symptom	Probable cause	Action
<ul style="list-style-type: none"> • No display (System switch On; LED lit; Fan running) <p>(The problem is most likely in the Control Module.)</p>	<ol style="list-style-type: none"> 1. Ribbon cable, control board to LCD display 2. LCD display 3. Control board 	<ol style="list-style-type: none"> 1. Check cable connection. 2. Replace LCD display. 3. Replace control board.
<p>The lit LED indicates that AC power is getting to the power supply. The power supply is most likely OK since it's supplying the 6V (VMAIN) to power the LED and fan (and the rest of the circuitry).</p>		

Symptom	Probable cause	Action
<ul style="list-style-type: none"> • Fan doesn't run (Everything else OK) <p>(The problem is most likely the fan or control board.)</p>	<ol style="list-style-type: none"> 1. Fan harness 2. Fan 3. Control board 	<ol style="list-style-type: none"> 1. Ensure fan harness is plugged in. 2. Replace fan. 3. Replace control board.
<p>Power for the fan (derived from VBUS) comes from the Power Section of the control board.</p>		

Symptom	Probable cause	Action
<ul style="list-style-type: none"> • No alarm audio (Alarm messages OK) <p>(The problem is most likely the speaker or control board.)</p>	<ol style="list-style-type: none"> 1. Speaker cable 2. Speaker 3. Control board 	<ol style="list-style-type: none"> 1. Ensure cable is plugged in. 2. Replace speaker. 4. Replace control board.
<p>Power for the speaker comes from the Power Section of the control board. Drive for the speaker comes from the Digital Section of the control board.</p>		

5.3 Alarm and Error messages

Alarm Message

Error Message

The Service Mode (refer to section 4) includes a log of the 20 most recent Alarm messages (not shaded) and Error messages (shaded) experienced by the ventilator system.

If a User Alarm persists after the recommended action has been performed, the message indicates the probable component and related circuit that needs repair. Use the Service Mode tests to isolate the fault. The items in the Service Repair column indicate the path from the named component to the control board.

Message	Alarm/Error	Cause	User Action/Concerns	Service Repair
12 Hour Test 	User Alarm	System in use for more than 12 hours without a powerup self test.	At end of case, move the system switch from On to Standby to On.	
+12V Analog Out-of- Range	Error Minimum Shutdown	Ventilator malfunction.	Ventilate manually. Monitoring is not reliable.	Replace: ▪ Control Board.
-12V Analog Out-of- Range	Error Minimum Shutdown	Ventilator malfunction.	Ventilate manually. Monitoring is not reliable.	Replace: ▪ Control Board.
12V -10VA Test Out-of-Range	Error Minimum Shutdown	Ventilator malfunction.	Ventilate manually. Monitoring is not reliable.	Replace: ▪ Control Board.
Absorber Panel Open	User Alarm	The top panel on Aestiva is not completely closed. ABS on Aespire in not completely engaged.	Close the panel. Reinstall ABS.	If persists, check: ▪ Panel switch ▪ Harness to MIA/VMB ▪ MIA/VMB ▪ Cable to CB/J12
A/D Converter Failure	Error Minimum Shutdown	Ventilator malfunction.	Ventilate manually. Monitoring is not reliable.	Replace: ▪ Control Board.
Apnea Alarm Standby	User Alarm	Normal condition after End Case, powerup, or ACGO change from On to Off.	Monitoring resumes after first breath (mechanical) or 2 breaths within 30 sec (non-mechanical).	
Apnea Alarm Off	User Alarm	The cardiac bypass option is selected (Alarm Settings menu).	Apnea alarms are turned off when this option is selected.	

Message	Alarm/Error	Cause	User Action/Concerns	Service Repair
Aux Gas Outlet On	User Alarm	The outlet selection switch is set to the auxiliary common gas outlet.	Connect the patient circuit to the auxiliary outlet. For mechanical ventilation or ventilation with monitoring, select the common gas outlet.	If persists, check: <ul style="list-style-type: none"> • ACGO switch • MIA/VMB • Cable to CB/J12
Battery Charger Fail	User Alarm	The current in the battery charging circuit is too high.	System is operational, but may fail on battery if mains power is lost.	Replace: <ul style="list-style-type: none"> • Battery • Control Board
Battery Charging \triangle	User Alarm	Battery is not fully charged.	Leave the system plugged in to charge the battery. If power fails, the total backup time will be < 30 minutes.	If persists, replace: <ul style="list-style-type: none"> • Battery • Control Board
Battery Current High	User Alarm	Battery current > 6 amps for 10 seconds.	System is operational, but may fail on battery if mains power is lost.	If persists, replace: <ul style="list-style-type: none"> • Battery • Control Board
Battery Failure High	User Alarm	Battery voltage > 8 V for 10 seconds.	System is operational, but may fail on battery if mains power is lost.	If persists, replace: <ul style="list-style-type: none"> • Battery • Control Board
Battery Failure Low	User Alarm	The battery voltage is too low (< 2 V) to supply the system if power fails.	System is operational, but may fail on battery if mains power is lost. Leave the system plugged in to charge the battery.	If persists, replace: <ul style="list-style-type: none"> • Battery • Control Board
Cal Flow Sensors	User Alarm	The last flow sensor calibration failed.	Calibrate the flow sensors. Look for water in the flow sensor tubes and dry if necessary. Replace sensor if necessary.	This alarm message indicates that the last flow sensor's differential pressure transducer calibration failed. With the BTV switch in Bag, ensure sensors are removed until the "No Insp / No Exp flow Sensor" messages appear. If persists, replace: <ul style="list-style-type: none"> • MIA/VMB • Control Board
Calibrate O ₂ Sensor	User Alarm	Calibration failure or O ₂ % >110%	Does the sensor measure 21% O ₂ in room air? Replace sensor if necessary.	If persists, Check: <ul style="list-style-type: none"> • O₂ sensor cable • MIA/VMB • Cable to CB/J12

7100 Anesthesia Ventilator

Message	Alarm/Error	Cause	User Action/Concerns	Service Repair
Canister Open	User Alarm	The canister release is open, causing a large leak (Aestiva only). (Closed by default in Aespire machine.)	Close the canister release.	If persists, check: <ul style="list-style-type: none"> ▪ Canister switch ▪ Harness to MIA/VMB ▪ MIA/VMB ▪ Cable to CB/J12
Cardiac Bypass	User Alarm	The alarm limit settings are set for a patient on cardiac bypass. Apnea alarms are off.	Use the alarm limits menu to change this setting.	
Check Flw Sensors 	User Alarm	System has detected an improper flow pattern in the breathing circuit.	Are the flow sensors correctly installed? Water build up in the flow sensor tubes? Is a flow sensor tube cracked or broken? Improper check valve operation? Inspect one-way valves. Replace flow sensor module with the spare. Check the condition of the flow sensor and its tubing.	
Circuit Leak Audio Off	User Alarm	Control setting on the Alarm Settings menu.	This message tells you that the audio alarm for circuit leaks was turned off.	
Connect O ₂ Sensor	User Alarm	The O ₂ sensor is not connected to the cable.	Connect the sensor.	If persists, Check: <ul style="list-style-type: none"> ▪ O₂ sensor cable ▪ MIA/VMB ▪ Cable to CB/J12
CPU Failure	Error Minimum Shutdown	Ventilator malfunction.	Ventilate manually. Monitoring is not reliable.	Replace: <ul style="list-style-type: none"> ▪ Control Board.
CPU Internal Error	Error Minimum Shutdown	Ventilator malfunction.	Ventilate manually. Monitoring is not reliable.	Replace: <ul style="list-style-type: none"> ▪ Control Board.
Exp Flow Sensor Fail	User Alarm	System cannot read the calibration data stored in the sensor.	Operation continues with reduced accuracy. Replace the flow sensor.	

Message	Alarm/Error	Cause	User Action/Concerns	Service Repair
Exp Reverse Flow	User Alarm	Flow through the expiratory sensor during inspiration (for 6 breaths in a row).	Look at the check valves. Water build up in the flow sensor tubes? Is a flow sensor tube cracked or broken? Replace the expiratory check valve. Check the flow sensor condition.	
Flow Valve (DAC) Failure	Error Minimum Monitoring	Ventilator malfunction.	Ventilate manually. Monitoring is still available.	Replace: • Control Board.
Flow Valve (Voltage) Failure	Error Minimum Monitoring	Ventilator malfunction.	Ventilate manually. Monitoring is still available.	Check/Replace: • Flow Valve • Flow Valve harness • PEB/VEB • Cable to CB/J14 • Control Board.
Heliox Mode is On	User Alarm	Control setting on ventilation setup menu.	When Heliox is used, the ventilator must adjust volume calculations.	
High O ₂	User Alarm	O ₂ % > alarm high limit setting.	Is the limit set correctly? What is the O ₂ flow? Did you just push Flush? Does the sensor see 21% O ₂ in room air? Calibrate O ₂ sensor. Replace O ₂ sensor.	
High Paw	User Alarm	Paw is greater than Plimit. The ventilator cycles to expiration.	Are Plimit and other controls set correctly? Look for blockages. Check patient connection.	
High V _E	User Alarm	The minute volume is greater than the set high limit. This alarm is suspended for 9 breaths after you change the ventilator settings.	Check patient for spontaneous breathing. Adjust control settings.	
High V _{TE}	User Alarm	V _{TE} is greater than high alarm limit. This alarm is suspended for 9 breaths after you change the ventilator settings.	Check patient for spontaneous breathing. Check ventilator and alarm settings.	
Insp Flow Sensor Fail	User Alarm	The system cannot read the calibration data stored in the sensor.	Operation continues with reduced accuracy. Replace the flow sensor.	

7100 Anesthesia Ventilator

Message	Alarm/Error	Cause	User Action/Concerns	Service Repair
Insp Reverse Flow	User Alarm	Flow through the inspiratory sensor during expiration (for 6 breaths in a row).	Look at the check valves. Water build up in the flow sensor tubes? Is a flow sensor tube cracked or broken? Replace the inspiratory check valve. Check the flow sensor condition.	
Inspiration Stopped ▲	User Alarm	Drive gas safety switch activated (high pressure).	Adjust controls. Check systems for blockages.	If persists, check: <ul style="list-style-type: none"> ▪ Bellows pop-off ▪ Exhalation valve
Internal Ventilator Clock Too Fast	Error Minimum Shutdown	Ventilator malfunction.	Ventilate manually. Monitoring is not reliable.	Replace: <ul style="list-style-type: none"> ▪ Control Board.
Internal Ventilator Clock Too Slow	Error Minimum Shutdown	Ventilator malfunction.	Ventilate manually. Monitoring is not reliable.	Replace: <ul style="list-style-type: none"> ▪ Control Board.
Invalid Circuit Module	User Alarm	The system does not recognize the type of circuit module installed. Normally the system uses the ID tabs to identify circuits.	Make sure the module is correctly installed. Look for broken ID tabs or tape on the tabs.	If persists, check: <ul style="list-style-type: none"> ▪ Circuit Identification Board ▪ Harness to MIA/VMB ▪ MIA/VMB ▪ Cable to CB/J12
Low Battery Voltage	User Alarm	Voltage is <5.65V while using battery power.	Manually ventilate the patient to save power. Is the mains indicator light on? Make sure power is connected and circuit breakers are closed. Check the ventilator fuse.	
Low Drive Gas Press	User Alarm	The ventilator does not detect supply pressure.	Manually ventilate the patient. Make sure that the appropriate gas supplies (O ₂ or Air) are connected and pressurized.	
Low O ₂	User Alarm	O ₂ % less than alarm low limit setting.	Is the limit set correctly? Is the O ₂ flow sufficient? Does the sensor see 21% O ₂ in room air? Calibrate O ₂ sensor. Replace O ₂ sensor. As sensors wear out, the measured % O ₂ decreases.	

Message	Alarm/Error	Cause	User Action/Concerns	Service Repair
Low Paw	User Alarm	Paw does not rise at least 4 cm above Pmin during the last 20 sec.	Are circuit connections OK? Look at the Paw gauge on the absorber. Look for circuit disconnection.	
Low \dot{V}_E	User Alarm	Exhaled minute volume less than low limit alarm setting. This alarm is suspended for 9 breaths after you change the ventilator settings.	Check patient condition. Check tubing connections. Check alarm settings.	
Low V_{TE}	User Alarm	Exhaled tidal volume less than low limit alarm setting. This alarm is suspended for 9 breaths after you change the ventilator settings.	Check patient condition. Check tubing connections. Check alarm settings.	
Memory (EEPROM) Fail	User Alarm	The system cannot access some stored values.	Default settings are used. Ventilation is still possible but service is necessary.	Replace: ▪ Control Board.
Memory (Flash) Failure	Error Minimum Shutdown	Ventilator malfunction.	Ventilate manually. Monitoring is not reliable.	Replace: ▪ Control Board.
Memory (RAM) Failure	Error Minimum Shutdown	Ventilator malfunction.	Ventilate manually. Monitoring is not reliable.	Replace: ▪ Control Board.
Memory (Redundant Storage) Failure	Error Minimum Shutdown	Ventilator malfunction.	Ventilate manually. Monitoring is still available.	Replace: ▪ Control Board.
Memory (Video) Failure	Error Minimum Shutdown	Ventilator malfunction.	Ventilate manually. Monitoring is not reliable.	Replace: ▪ Control Board.
Monitoring Only	User Alarm	A severe malfunction prevents mechanical ventilation. Other alarms may also occur.	Ventilate manually. Cycle system power (On- Standby-On). If the alarm clears, restart mechanical ventilation.	Replace: ▪ Control Board.
No Circuit Module	User Alarm	The patient circuit module is not installed (Aestiva only).	Install a module. Optical sensors look for tabs on the back of the module. Is the module assembled? Are sensors dirty?	If persists, check: ▪ Circuit Identification Board ▪ Harness to MIA/VMB ▪ MIA/VMB ▪ Cable to CB/J12

7100 Anesthesia Ventilator

Message	Alarm/Error	Cause	User Action/Concerns	Service Repair
No CO ₂ Absorption	User Alarm	CO ₂ bypass selected (Aestiva only).	User setting. Close the canister release to remove CO ₂ from exhaled gas.	
No Exp Flow Sensor	User Alarm	Electrical signals show the flow sensor is not connected.	Connect the flow sensors. Make sure the flow sensor module is on all the way.	
No Insp Flow Sensor	User Alarm	Electrical signals show the flow sensor is not connected.	Connect the flow sensors. Make sure the flow sensor module is on all the way.	
No O ₂ Pressure	User Alarm	The O ₂ supply has failed.	Air flow will continue. Ventilate manually if necessary. Connect a pipeline supply or install an O ₂ cylinder.	
O ₂ Flush Failure	User Alarm	The pressure switch that detects flush flow has seen a very long flush (≥30 sec).	This alarm occurs if you hold down the Flush button for more than 30 seconds.	If persists, check: <ul style="list-style-type: none"> ▪ O₂ flush switch ▪ Cable to SAB/SICB ▪ SAB/SICB ▪ Cable to CB/J11
O ₂ Sensor Out of Circ	User Alarm	O ₂ sensor not installed in breathing circuit module. Sensor not measuring gas in breathing circuit.	Install a breathing circuit module and an O ₂ sensor.	
O ₂ Mon Disabled	User Alarm	An Oxygen cell has been connected to a non-active ventilator monitoring feature.	The Oxygen Monitoring feature is not active on this system.	Service Mode: <ul style="list-style-type: none"> ▪ System Configurations
On Battery - Power OK?	User Alarm	The mains supply is not connected or has failed and the system is using battery power.	Ventilate manually to save power. At full charge, the battery permits approximately 30 minutes of mechanical ventilation. Make sure power is connected and circuit breakers are closed. Check the ventilator fuse.	
Patient Circuit Leak?	User Alarm	Exhaled volume <50% of inspired volume for at least 30 seconds (mechanical ventilation).	Check breathing circuit and flow sensor connections. Patient circuit leak audio can be turned off in the Alarm Settings menu.	

Message	Alarm/Error	Cause	User Action/Concerns	Service Repair
Paw < -10 cm H ₂ O	User Alarm	Subatmospheric pressure (<-10 cm H ₂ O).	Check patient condition, spontaneous activity? Increase fresh gas flow. Look for high flow through gas scavenging. Calibrate the flow sensors. With active scavenging, check the negative relief valve on the receiver.	
PEEP Valve (DAC) Failure	Error Minimum Monitoring	Indicates a failure of the control circuit for the PEEP Valve.	Ventilate manually.	Replace: • Control Board.
PEEP Valve (Voltage) Failure	Error Minimum Monitoring	Indicates a problem with the PEEP Valve or the connections to the PEEP Valve.	Ventilate manually.	Check/Replace: • PEEP Valve • PEEP Valve harness • PEB/VEB • Cable to CB/J14 • Control Board.
PEEP Safety Valve (Drive) Failure	Error Minimum Monitoring	Indicates a higher than allowed current draw on the PEEP Safety Valve.	Ventilate manually.	Check/Replace: • PEEP Safety Valve • PEEP Safety Valve harness • PEB/VEB • Cable to CB/J14 • Control Board.
PEEP Safety Valve Failure	Error Minimum Monitoring	Indicates that the powerup test of the PEEP Safety Valve failed.	Ventilate manually.	Check/Replace: • PEEP Safety Valve • PEEP Safety Valve harness • PEB/VEB • Cable to CB/J14 • Control Board.
Pinsp Not Achieved	User Alarm	Indicates a problem with breathing circuit connections or that the ventilator is unable to deliver requested pressure to the patient.	Check breathing circuit connections. Check settings.	
Pressure Monitoring Channel Failure	Error Minimum Monitoring	Indicates a problem with patient airway overpressure monitor.	Ventilate manually.	Check/Replace: • PEB/VEB • Cable to CB/J14 • Control Board.

7100 Anesthesia Ventilator

Message	Alarm/Error	Cause	User Action/Concerns	Service Repair
Pres/Vol Mon Inactive	User Alarm	ACGO is set to auxiliary gas outlet.	Connect the patient circuit to the auxiliary gas outlet or set the switch to the common gas outlet for normal operation.	
Replace O ₂ Sensor	User Alarm	O ₂ % < 5%	Make sure patient receives O ₂ . Does the sensor see 21% O ₂ in room air? Use different monitor. Calibrate O ₂ sensor. Replace O ₂ sensor.	If persists, check: <ul style="list-style-type: none"> ▪ O₂ sensor cable ▪ MIA/VMB ▪ Cable to CB/J12 ▪ Control board
Service Calibration ▲	User Alarm	Internal calibrations are necessary for maximum accuracy.	The system is operational.	Service Mode: <ul style="list-style-type: none"> ▪ Calibrations
Select Gas Outlet	User Alarm	Fresh gas may not flow to the patient. ACGO is On, but flow sensors have seen 3 breaths in patient circuit during the last 30 seconds.	Select the common gas outlet or connect the patient circuit to the ACGO. Note: The bag arm will not ventilate a patient at the auxiliary outlet.	
Software Error	Error Minimum Shutdown	Indicates that a software error has occurred.	Ventilate manually. Monitoring is not reliable.	Replace: <ul style="list-style-type: none"> ▪ Software ▪ Control Board.
Software Watchdog Failure	Error Minimum Shutdown	Ventilator malfunction.	Ventilate manually. Monitoring is not reliable.	Replace: <ul style="list-style-type: none"> ▪ Control Board.
Sustained Airway Pressure	Error Minimum Shutdown	Paw > 100 cm H ₂ O for 10 sec.	Check tubing for kinks, blockages, disconnects. Calibrate the flow sensors.	If persists, check: <ul style="list-style-type: none"> ▪ Bellows pop-off ▪ Exhalation valve
Sustained Paw	User Alarm	Paw is greater than sustained pressure limit for 15 seconds.	Check tubing for kinks, blockages, disconnects. Calibrate the flow sensors.	
System Configuration (EEPROM) Memory Failure	Error Minimum Shutdown	System configuration information is bad in the EEPROM Memory.	Ventilate manually. Monitoring is not reliable.	Replace: <ul style="list-style-type: none"> ▪ Control Board.

Message	Alarm/Error	Cause	User Action/Concerns	Service Repair
System Leak?	User Alarm	Leak detected between ventilator and patient circuit.	If you are using Heliox, select Heliox on the ventilator setup menu. Look for leaks in the absorber system. Problem with flow sensors? Calibrate the flow sensors. Drain water buildup from the breathing system and inspect for leaks (repair). Inspect or replace flow sensors.	The primary cause for this message is that the bellows has emptied. Refill the bellows. This message combines the "Unable to Drive Bellows" and "System Leak?" messages in the Aestiva 7900 Ventilator. Perform the Breathing System Leak Tests.
Vext_ref Out-of-Range	Error Minimum Shutdown	Ventilator malfunction.	Ventilate manually. Monitoring is not reliable.	Replace: ▪ Control Board.
VBUS Fail Out-of-Range	Error Minimum Shutdown	Ventilator malfunction.	Ventilate manually. Monitoring is not reliable.	Replace: ▪ Control Board.
Ventilate Manually	User Alarm	A severe malfunction prevents mechanical ventilation and monitoring. Other alarms may also occur.	Ventilate manually. Use a stand-alone monitor. Cycle system power (On-Standby-On). If the alarm clears, restart mechanical ventilation.	Replace: ▪ Control Board.
Verify Low \dot{V}_E Limit	User Alarm	The audible circuit leak alarm is off (Alarm Settings menu) but the low \dot{V}_E alarm is not consistent with the ventilator settings.	Set the low \dot{V}_E alarm.	
Volume Apnea	User Alarm	No mechanical breaths or spontaneous breaths > 5 mL in last 30 seconds.	Check patient. Bag as needed. Check for disconnects. If the patient is on a heart lung machine, select Cardiac Bypass on the alarm menu.	
Vol Apnea > 2 min	User Alarm	No mechanical breaths or spontaneous breaths > 5 mL in last 120 seconds.	Check patient. Bag as needed. Check for disconnects. If the patient is on a heart lung machine, select Cardiac Bypass on the alarm menu.	

7100 Anesthesia Ventilator

Message	Alarm/Error	Cause	User Action/Concerns	Service Repair
Volume Mon Disabled	User Alarm	A flow sensor has been connected to a non-active ventilator monitoring feature.	The Volume Monitoring feature is not active on this system.	Service Mode: <ul style="list-style-type: none"> ▪ System Configurations
V _r Comp Avail	User Alarm	A condition which prevented V _r Compensation ventilation mode has cleared.	None. Indicates a return to normal operation. Select Volume Mode or Pressure Mode (if available).	
V _r Comp Off	User Alarm	The system supplies the set breath but cannot adjust ventilation for compliance and resistance losses, etc.	Adjust V _r manually and continue without compensation, or change to the pressure mode. In pressure mode set P _{inspir} . Replace the flow sensor module and select the mode again. If the problem stops, inspect the two flow sensors.	
V _r Comp Disabled	User Alarm	A flow sensor has been connected to a non-active ventilator monitoring feature.	The Volume Compensated Delivery feature is not active on this system.	Service Mode: <ul style="list-style-type: none"> ▪ System Configurations
V _r Not Achieved	User Alarm	Tidal volume measured by inspiratory flow sensor is less than set value 6 breaths in a row after the first minute of mechanical ventilation.	Adjust controls to supply adequate tidal volumes. Check I:E; P _{limit} ; and volume settings. Possible leak.	
V _T E > Insp V _r	User Alarm	Expired volume is greater than inspired volume for 6 breaths with a circle module.	Check patient condition. Are the flow sensors correctly installed? Water build up in the flow sensor tubes? Is a flow sensor tube cracked or broken? Improper check valve operation? Inspect one-way valves (breathing circuit module.) Replace flow sensor module with the spare. Check the condition of the flow sensor and its tubing.	
V _r Delivery Too High	User Alarm	V _r > 20% of set value for six consecutive breaths.	Reduce fresh gas flow.	

5.4 Troubleshooting Flowcharts

5.4.1 Ventilator assessment process

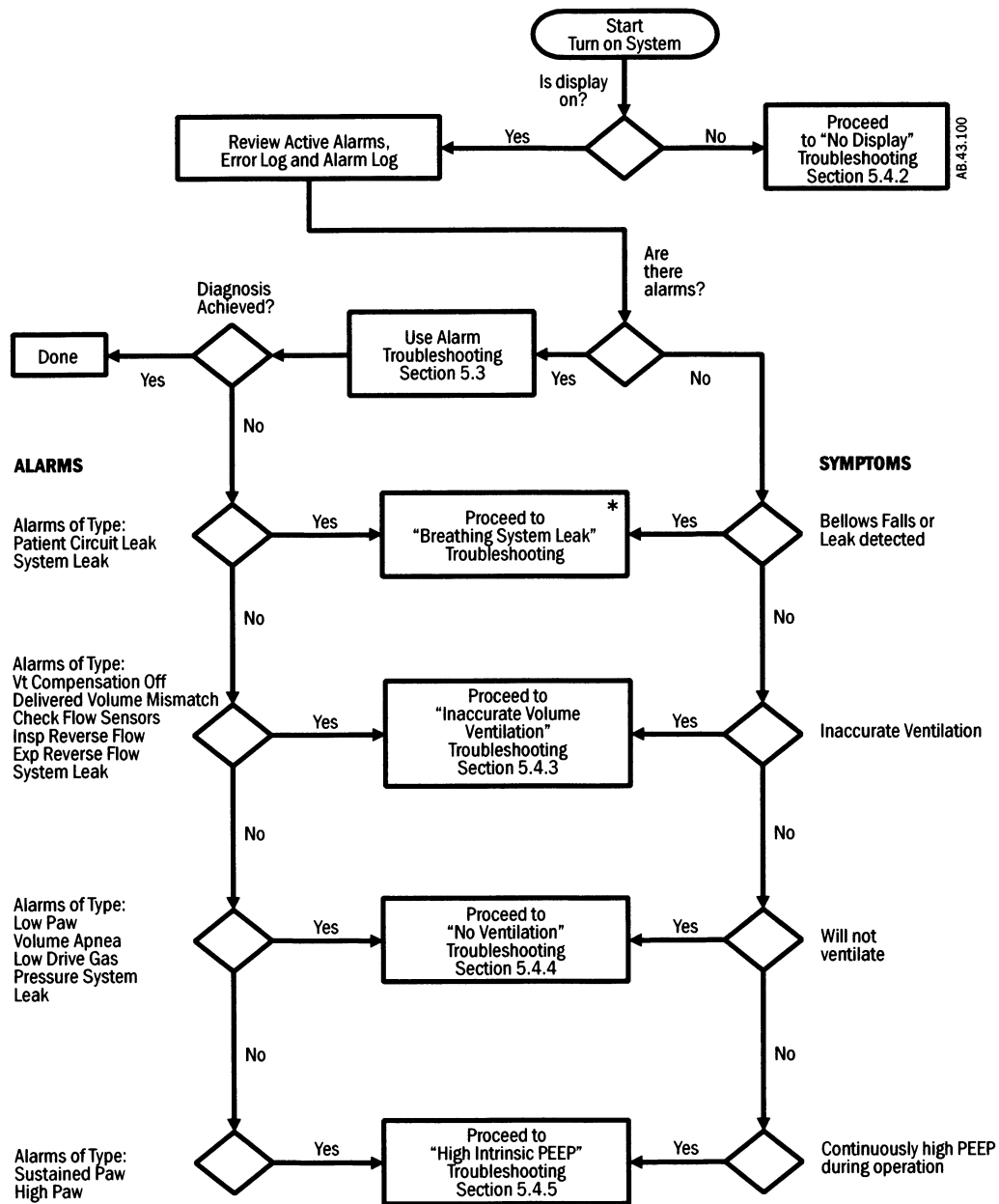

* Refer to Section 7.2, "Breathing System Leak Tests," in the respective anesthesia machine Technical Reference Manual.

5.4.2 No display troubleshooting

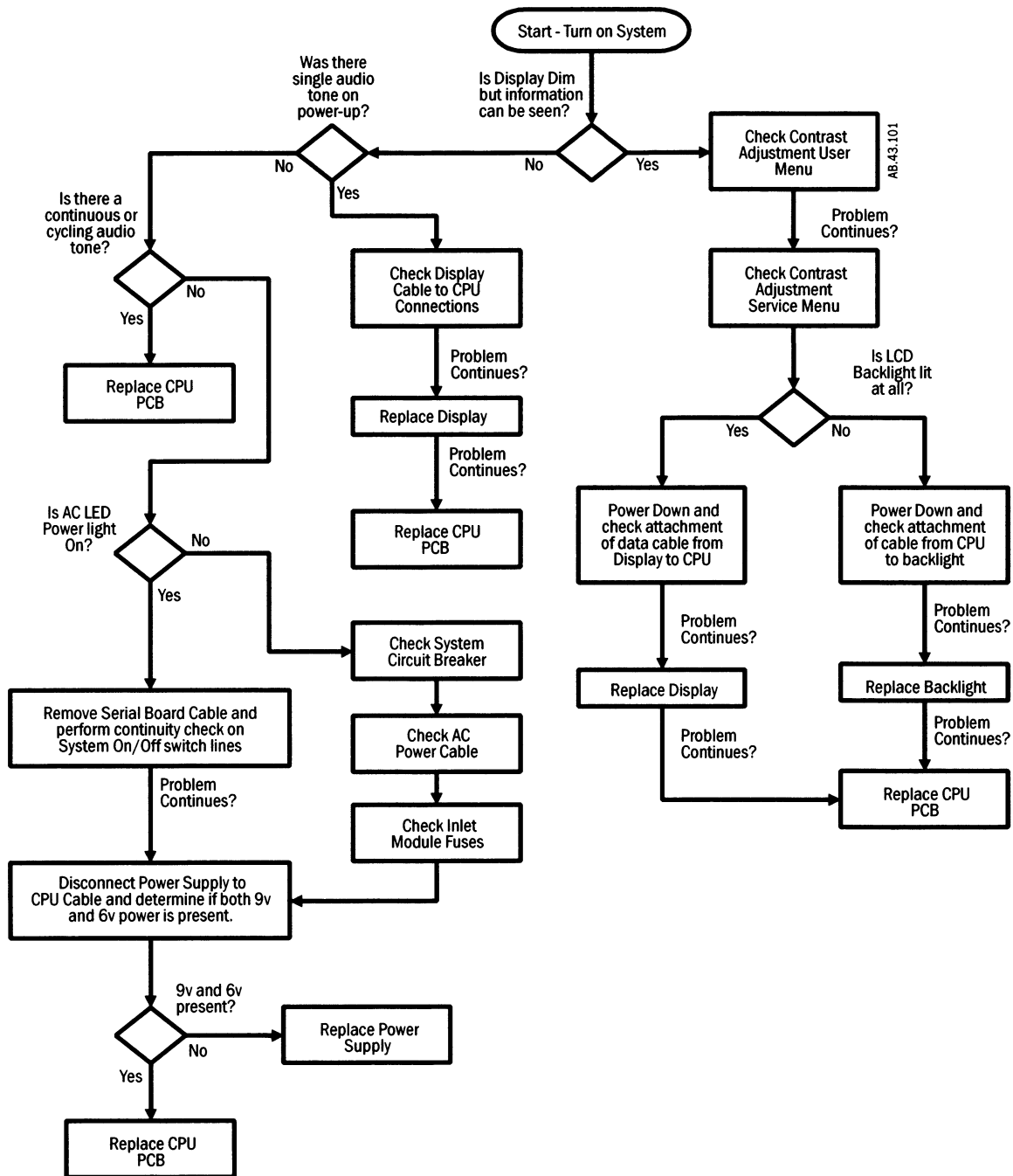

AB 43.101

5.4.3 Inaccurate volume ventilation troubleshooting

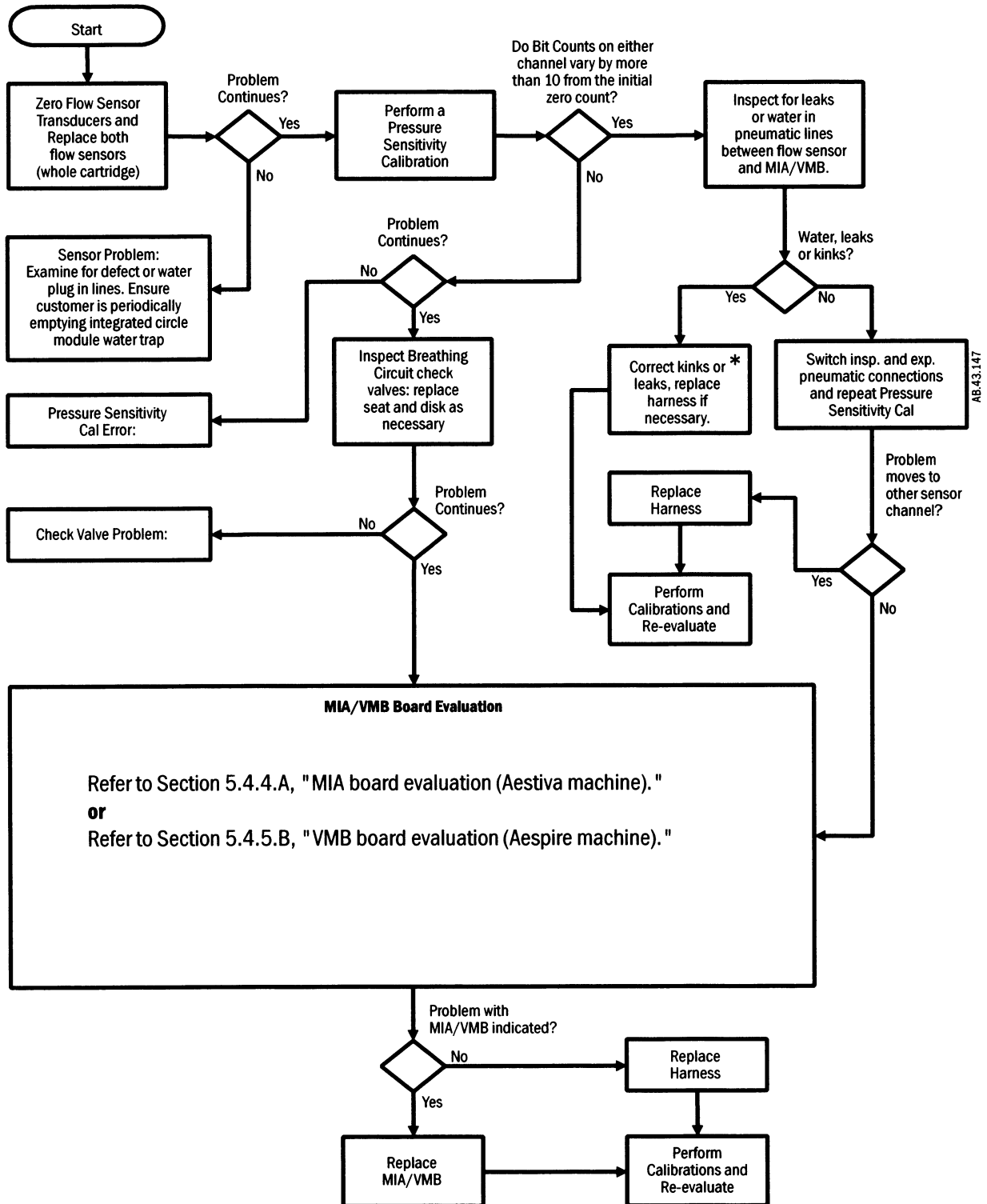

* Water in harness is indicative of a leak in the tubing, connectors, or MIA/VMB pressure transducer. Be sure to leak check if it is determined that water is present within the harness.

**5.4.4.A MIA board
evaluation
(Aestiva machine)**

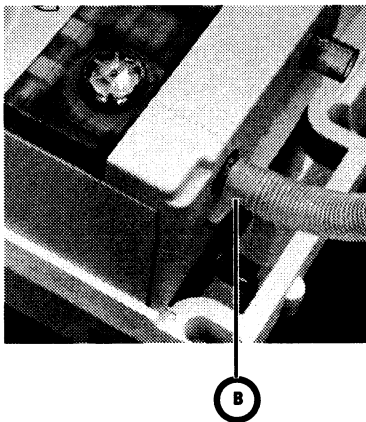
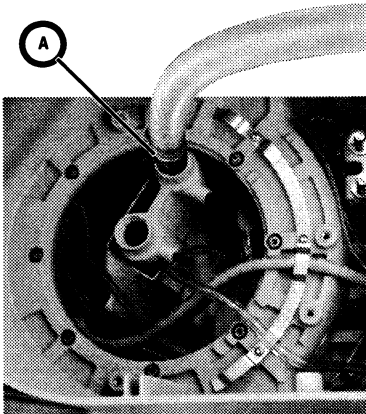

1. Remove the Bellows Assy and Breathing Circuit subfloor to access the MIA pneumatic circuit connections.
2. Enter the Valves-Test Tool service page and record the bit counts on the inspiratory and expiratory flow transducers.
3. Connect the calibration orifice test tool (A) to the drive gas port (not the pilot pressure port used for PEEP calibration).
4. Install the flow sensor module only (no circuit module).
5. Connect a 22-mm hose from the calibration orifice test tool to the inspiratory flow port (B).
6. Set the inspiratory flow valve to 60 L/min. Gas will exhaust out the rear of the inspiratory flow sensor where it is normally connected to the circuit module (reverse flow through the inspiratory flow sensor).
7. Record the change in bit counts observed on the inspiratory flow transducer channel as compared to step 2 (negative polarity). There may be some variation in the last digit of the counts, try to pick the average value.
8. Stop the inspiratory flow.

Refer to Figure 9-7 •

9. Swap the inspiratory channel pneumatic connections (white to black, black to white)
10. Repeat steps 6 through 8.
11. Move the two inspiratory connections to the expiratory channel of the MIA (white from harness to blue of MIA pressure transducer, black from harness to yellow of MIA pressure transducer).
12. Repeat steps 6 through 8 using counts from the expiratory flow transducer channel.
13. Swap the two inspiratory connections to the expiratory channel of the MIA (white from harness to yellow of MIA pressure transducer, black from harness to blue of MIA pressure transducer).
14. Repeat steps 6 through 8 using counts from the expiratory flow transducer channel.
15. Variation of greater than 40 bits in any of the four measured count changes indicates a problem with the MIA function.
16. Return to Section 5.4.3.

5.4.5.B VMB board evaluation (Aespire machine)

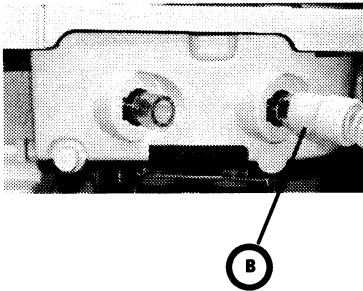
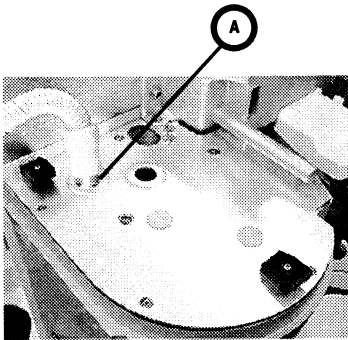

1. Remove the tabletop to access the VMB pneumatic circuit connections.
 2. Remove the ABS and the exhalation valve.
 3. Enter the Valves-Test Tool service page and record the bit counts on the inspiratory and expiratory flow transducers.
 4. Connect the calibration orifice test tool (A) to the drive gas port (not the pilot pressure port used for PEEP calibration).
 5. Separate the Bellows Module from the Circuit Module.
 6. Remove the Flow Sensor Module from the ABS and install it on the machine .
 7. Install the Circuit/Flow Sensor Module.
 8. Connect a 22-mm hose from the calibration orifice test tool to the inspiratory flow port (B).
 9. Set the inspiratory flow valve to 60 L/min. Gas will exhaust out the rear of the inspiratory flow sensor where it is normally connected to the circuit module (reverse flow through the inspiratory flow sensor).
 10. Record the change in bit counts observed on the inspiratory flow transducer channel as compared to step 2 (negative polarity). There may be some variation in the last digit of the counts, try to pick the average value.
 11. Stop the inspiratory flow.
- Refer to Figure 9-9 ▪
12. Swap the inspiratory channel pneumatic connections (white to black, black to white)
 13. Repeat steps 9 through 11.
 14. Move the two inspiratory connections to the expiratory channel of the VMB (white from harness to blue of VMB pressure transducer, black from harness to yellow of VMB pressure transducer).
 15. Repeat steps 9 through 11 using counts from the expiratory flow transducer channel.
 16. Swap the two inspiratory connections to the expiratory channel of the VMB (white from harness to yellow of VMB pressure transducer, black from harness to blue of VMB pressure transducer).
 17. Repeat steps 9 through 11 using counts from the expiratory flow transducer channel.
 18. Variation of greater than 40 bits in any of the four measured count changes indicates a problem with the VMB function.
 19. Return to Section 5.4.3.

5.4.6 No ventilation troubleshooting

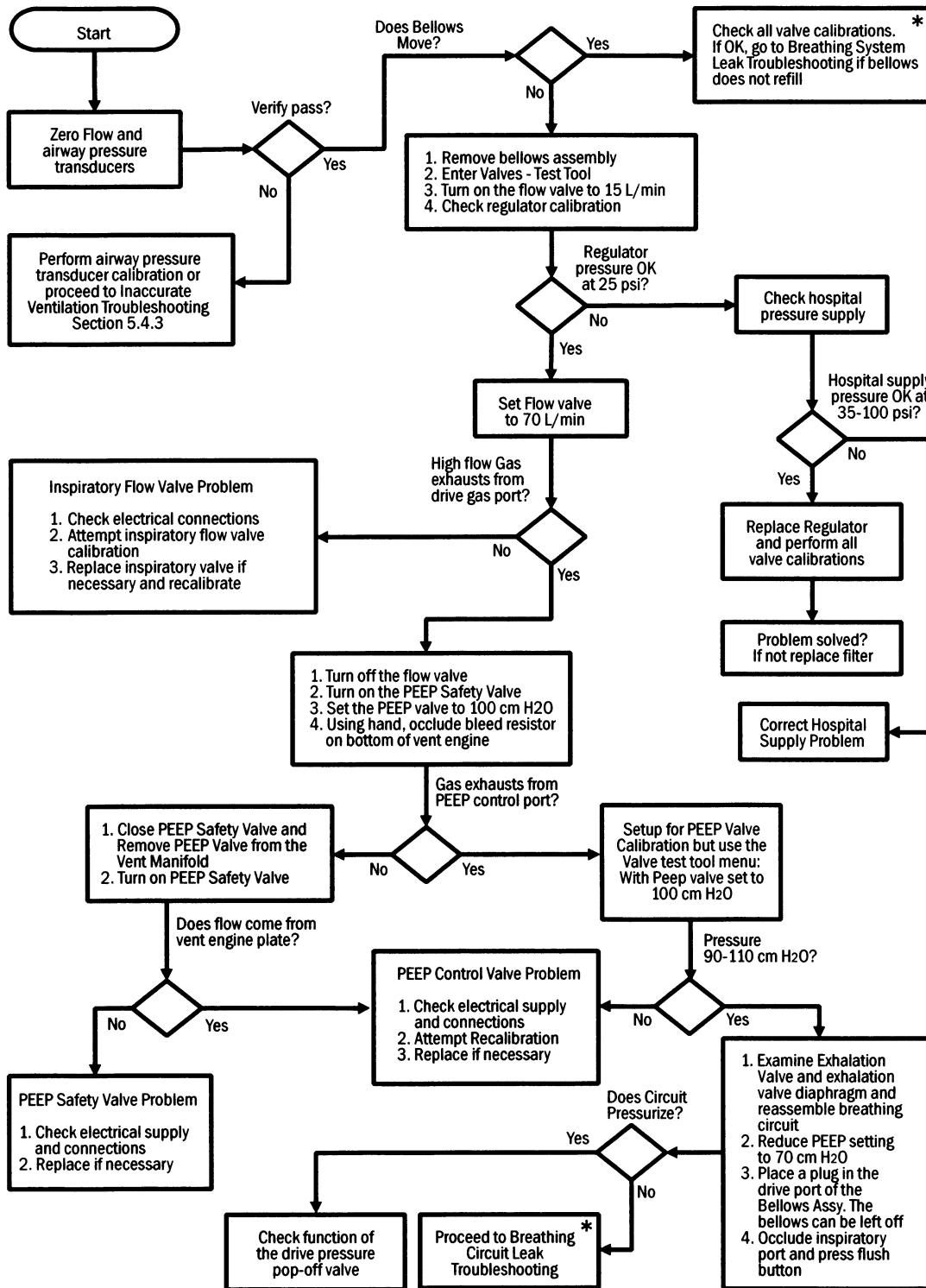

AB.43.103

* Refer to Section 7.2, "Breathing System Leak Tests," in the respective anesthesia machine Technical Reference Manual.

5.4.7 High Intrinsic PEEP troubleshooting

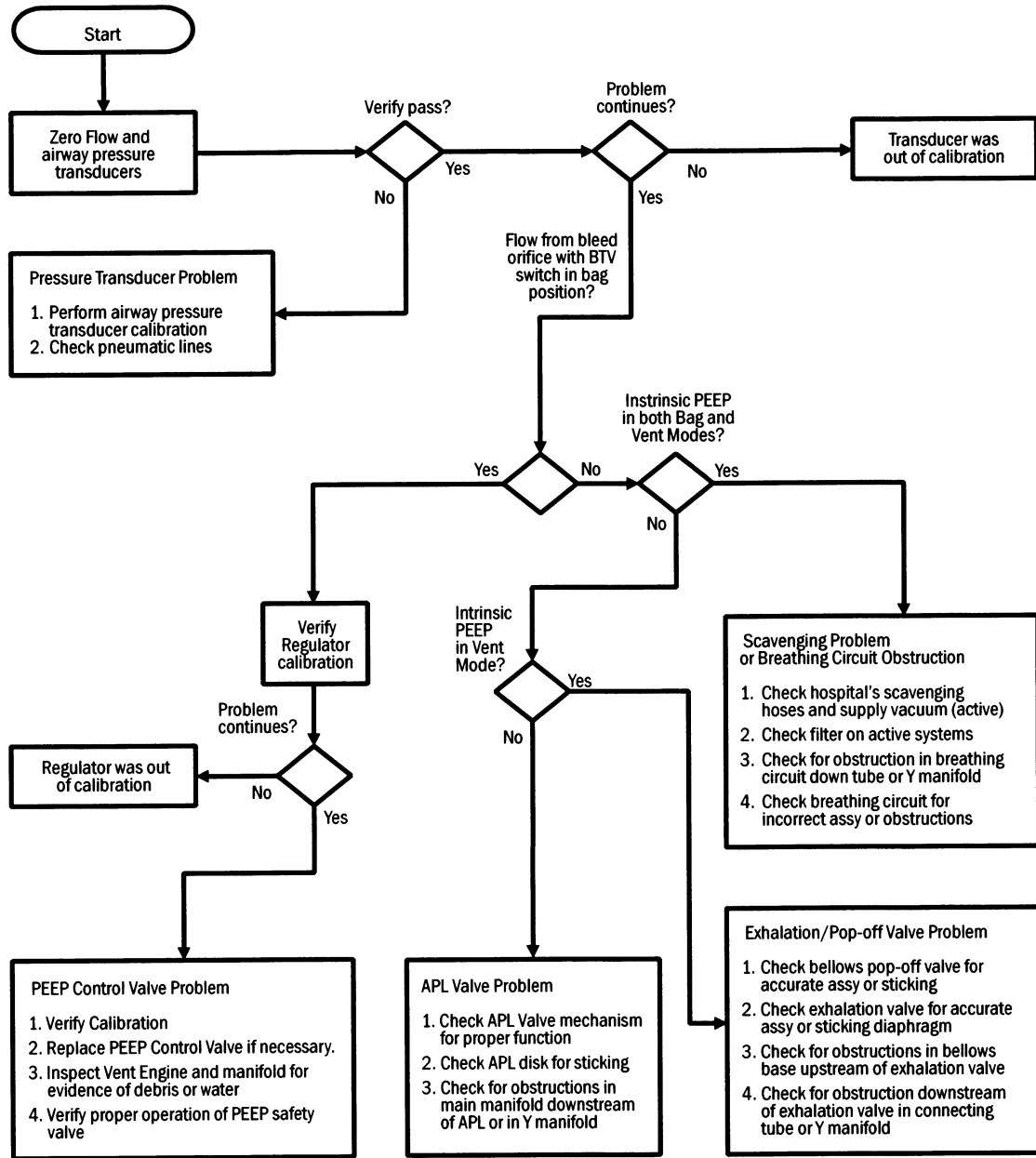

AB.43.104

Notes

6 Maintenance

In this section

- The “*Maintenance Schedule*,” Section 6.1, applies to the entire anesthesia machine.
- The remaining sections, Sections 6.2 and 6.3, detail select maintenance procedures that apply only to the 7100 Ventilator.

6.1 Maintenance Schedule	6-2
6.2 Free breathing valve maintenance	6-3
6.3 MOPV pressure relief valve test	6-4
6.3.1 Test setup	6-4
6.3.2 Test procedure	6-4

7100 Anesthesia Ventilator

- ⚠ **WARNING** Do not perform testing or maintenance on this instrument while it is being used to ventilate a patient. Possible injury can result.
- ⚠ **WARNING** Items can be contaminated due to infectious patients. Wear sterile rubber gloves. Contamination can spread to you and others.
- ⚠ **WARNING** Obey infection control and safety procedures. Used equipment may contain blood and body fluids.

6.1 Maintenance Schedule

The 7100 Ventilator is an integral component of the Aestiva/5 7100 anesthesia machine and the S/5 Aespire anesthesia machine.

Refer to Section 5, “*Maintenance*,” in the respective anesthesia machine Technical Reference manual for the “*Planned Maintenance Schedule*.”

6.2 Free breathing valve maintenance

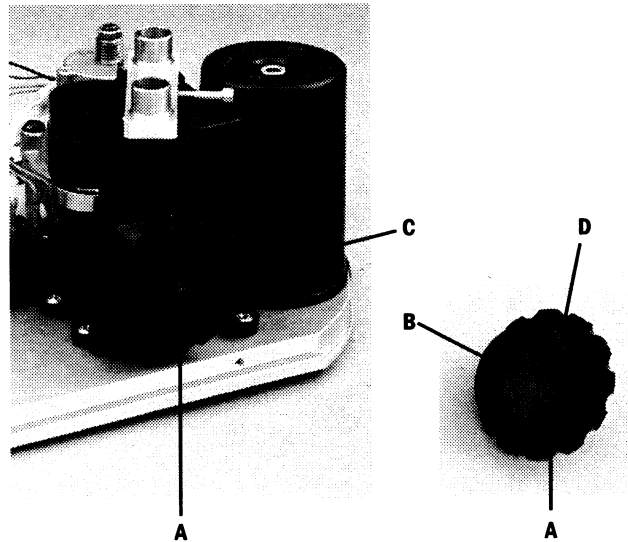

Figure 6-1 • Free breathing valve

Refer to Section 7.3 to access the Pneumatic Vent Engine.

To replace the flapper valve

1. Unscrew the valve seat (A) from the side of the interface manifold.
2. Inspect the flapper (B) and valve seat for nicks, debris and cleanliness.
3. If necessary, clean the new flapper valve with alcohol.
4. Pull the tail (C) of the new free breathing valve flapper through the center of the valve seat until it locks in place.
5. Trim the tail flush with outside surface of the valve seat (refer to the removed flapper).
6. Replace the O-ring (D). Lubricate with a thin film of Krytox.
7. Hand screw the assembly into the interface manifold.
8. Reassemble the system.
9. Perform the Preoperative Checkout Procedure (refer to the respective User's Reference manual).

6.3 MOPV pressure relief valve test

⚠ WARNING Objects in the breathing system can stop gas flow to the patient. This can cause injury or death:

- Do not use a test plug that is small enough to fall into the breathing system.
- Make sure that there are no test plugs or other objects caught in the breathing system.

6.3.1 Test setup

1. Disassemble the breathing system to the point where you can remove the exhalation valve (do not remove the exhalation valve on Aespire machine).
2. Plug the inspiratory flow (drive pressure) port with a stopper.

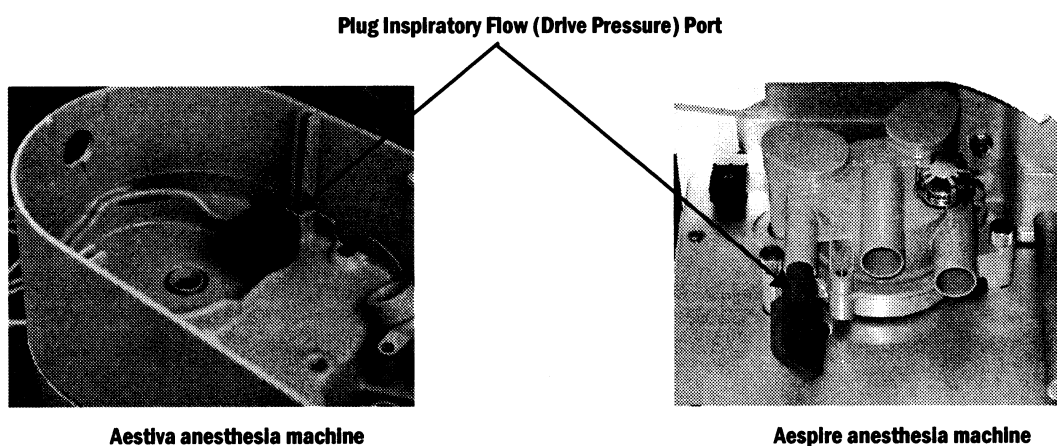

Figure 6-2 • Occluding the inspiratory flow port

6.3.2 Test procedure

1. Set the system switch to On and enter the Service Mode.
2. Select “Diagnostic Tests/Tools”; select “Valves - Test Tool”.
3. Select “Set Inspiratory Valve” and activate a flow of 10 L/min.
4. Carefully listen for the MOPV relief weight to be relieving and “popping off” from its seat (a purring sound). This indicates the valve is functioning correctly.
5. Set the system switch to Standby.
6. Remove the stopper from the inspiratory flow port.
7. Reassemble the system.
8. Perform the Preoperative Checkout Procedure (refer to the respective User’s Reference manual).

7 Repair Procedures

In this section

This section covers the repair and replacement procedures for the 7100 Ventilator and its related components.

7.1 Software Installation	7-2
7.1.1 After replacing the Control Board or the Control Module	7-3
7.2 Control Module	7-4
7.2.1 Inside the control module	7-5
7.2.2 Control board	7-6
7.2.3 Battery and power supply	7-7
7.2.4 Front enclosure with control board removed	7-8
7.2.5 Front enclosure components	7-9
7.3 Pneumatic engine	7-11
7.3.1 Pneumatic Engine in an Aestiva machine	7-11
7.3.2 Pneumatic Vent Engine in an Aespire machine	7-12
7.3.3 Pneumatic engine components (Aespire machine)	7-13
7.3.4 Pneumatic engine components (Aestiva machine)	7-14
7.3.5 Supply gas inlet filter (Aestiva machine)	7-15
7.3.6 Insp/PEEP interface assembly and reservoir	7-16
7.3.7 Manifold and plate assembly	7-17
7.3.8 Pneumatic Engine Board and housing (Aestiva machine)	7-18
7.4 Monitoring Interface Assembly (MIA) in an Aestiva machine	7-19
7.5 Serial Adapter Board (SAB) and Power Cord/Harness	7-20

⚠ WARNING Post-Service Checkout is required after you complete this section. You must perform Section 3, “Post-Service Checkout,” after performing any maintenance, service, or repair. Failure to do so may result in patient injury.

⚠ WARNING When servicing the ventilator, extreme care must be taken to avoid introducing foreign debris, particularly metal chips generated by screw threads, into the pneumatic flow passages of the ventilator. Failure to do so can result in damage to the flow valve and possible injury to the patient.

7.1 Software Installation

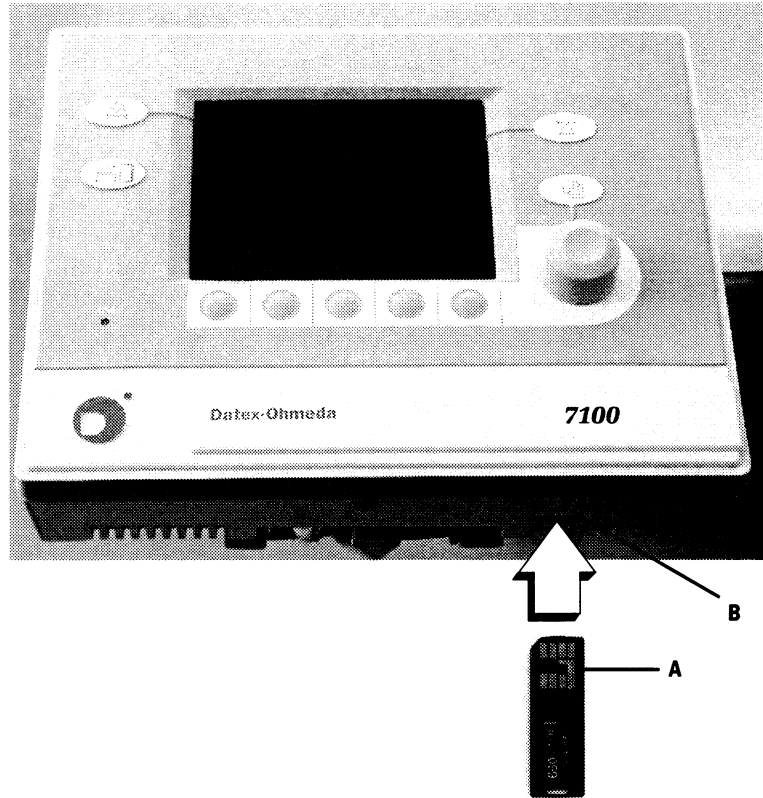

1. Set the system switch to Standby.
2. Insert the Software Memory Stick (A) with contacts facing forward into the upgrade slot (B) of the Control Module.
3. Set the system switch to On.
4. Follow the instructions on the screen to complete the installation.
5. Set the system switch to Standby.
6. Remove the Software Memory Stick.
7. Perform the preoperative checkout procedure.

7.1.1 After replacing the Control Board or the Control Module

1. Load the appropriate software revision using a software memory stick that matches the software revision of the replaced control board (control module).
2. Enable/Disable the appropriate ventilator settings in the **Service Mode, System Configuration** menu, Section 4.8, to match the replaced control board.
3. Install new control board configuration label on back of control module (with Control Board BID number and Feature KEY code). The replacement control module has the label already attached.

Replacement Control Board

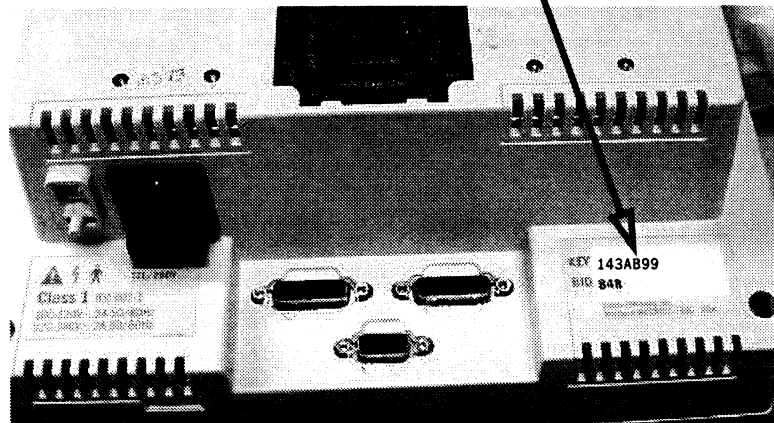
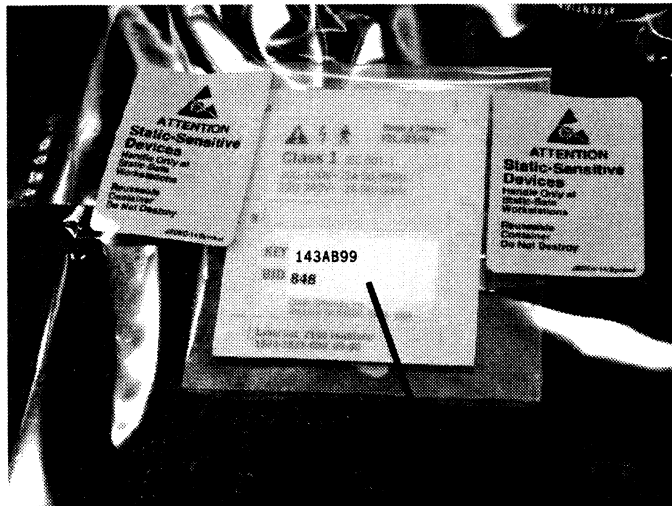

7.2 Control Module

The control module is mounted on either a folding mount or on a repositionable arm. In addition to the power cord, signals between the control module and the machine mounted components are sent through three cables that pass through the side of the machine (and through the arm if equipped) and connect to the rear of the control module.

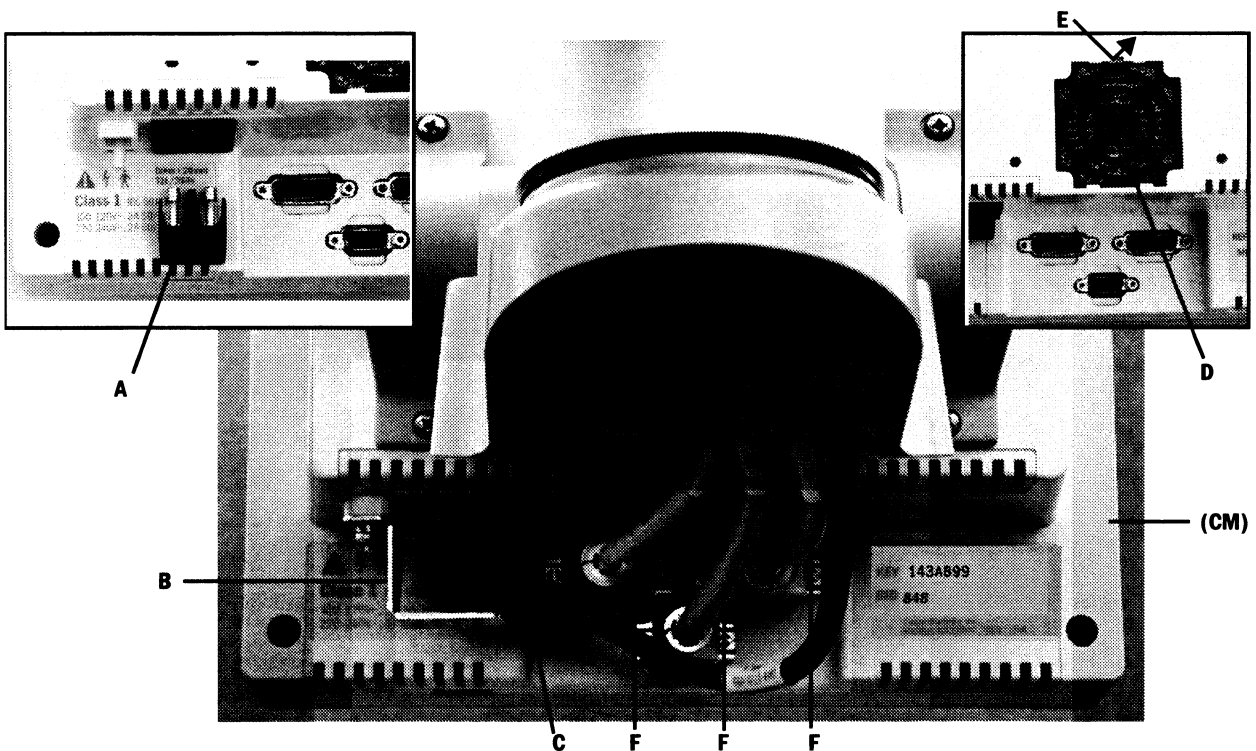

To replace the fuses and the fan filter

- To replace the fuses (A), first remove the power cord retainer (B) and the power cord (C).
- To replace the filter (D), remove the filter retainer (E). If the Control Module is mounted on an arm, remove the control panel from the arm to access the filter.

To remove the control module

1. Disconnect the three interface cables (F) and the power cord (C).
2. Remove the screws that attach the control module to the mounting brackets.
3. Remove the control module (CM).
4. Reassemble in reverse order.
5. Refer to Section 7.1 for installing software and updating the control board configuration.

7.2.1 Inside the control module

The control module consists of two enclosures: the rear enclosure (A) and the front enclosure (B). To access components within each enclosure, separate the two halves.

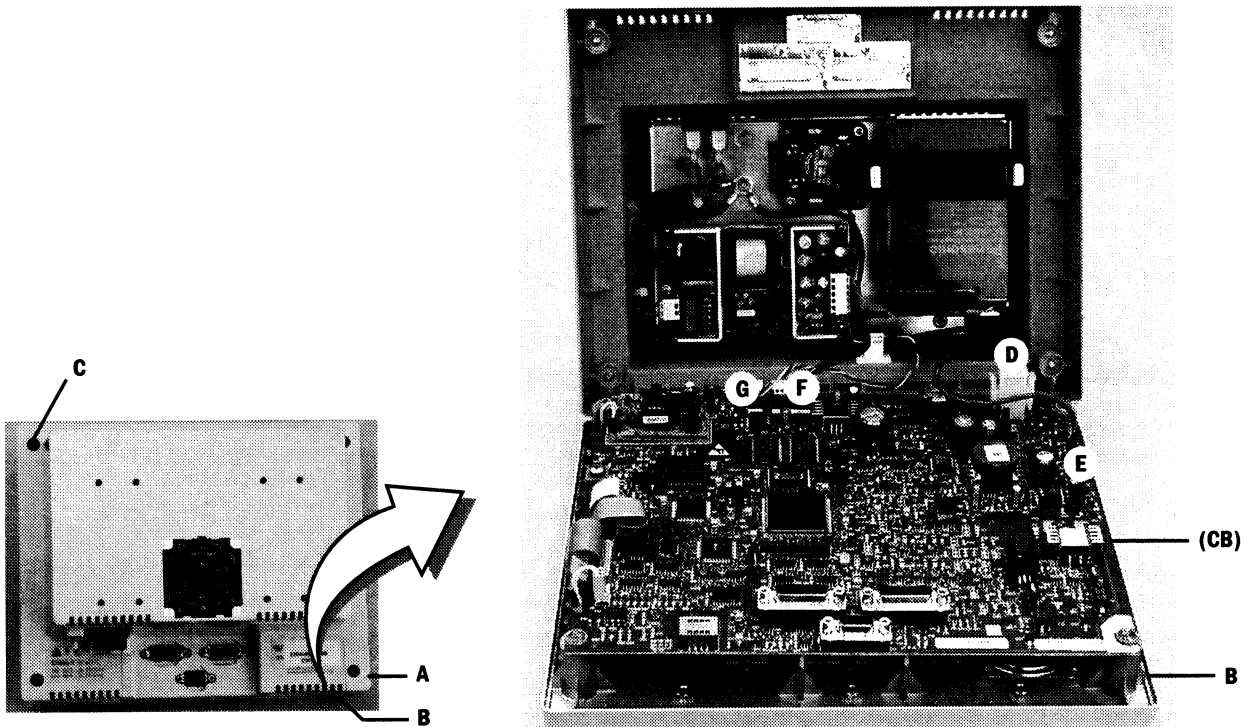

Opening the control module

1. Place the control module face down on a protected surface.
2. Loosen the screws (C) that hold the two enclosures together (one in each corner).
3. Slightly separate the rear enclosure (A) from the front enclosure (B).
4. Swing the rear enclosure into an upright position. Lift up the edge that houses the external connectors. Be careful not to stress the harnesses in the back.
5. Disconnect the harnesses from the back of control board (CB) to separate the two enclosures.
 - Battery (D)
 - Ground (E)
 - Power supply (F)
 - Fan (G)

⚠ Caution When disassembling, remove the battery connector first. When reassembling, attach the battery connector last. Power is supplied to the control board as long as the battery is plugged in.

7.2.2 Control board

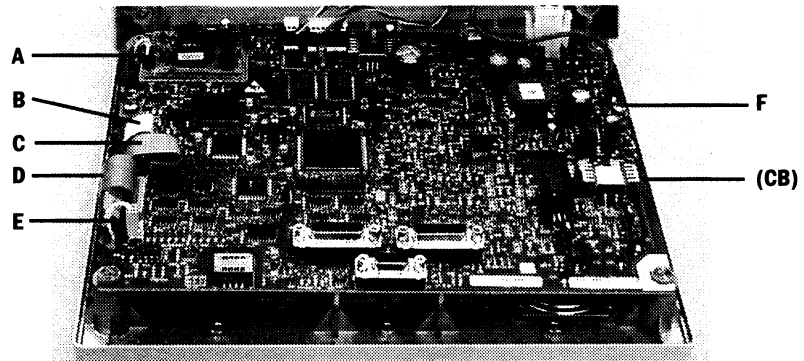

⚠ Caution The circuit boards are electrostatic sensitive. Use an anti-static workstation and wear a wrist grounding strap when handling a circuit board.

To replace the control board

1. Disconnect the remaining cables at the left edge of the control board (CB).
 - (A) Two-wire harness to display backlight
 - (B) Ribbon cable to LCD display
 - (C) Ribbon cable to rotary encoder
 - (D) Ribbon cable to front panel keyboard (**refer to Note**)
 - (E) Two-wire harness to speaker
2. Remove the two screws (F) that hold the control board to the front enclosure.
3. Carefully lift the control board from the front enclosure. Guide the cables through the slotted openings at the left edge of the control board.
4. Reassemble in reverse order.
5. Refer to Section 7.1 for installing software and attaching the control board configuration label.

Note The ribbon cable for the front panel keyboard inserts into a ZIF (zero insertion force) connector on the control board.

To release the ribbon cable, insert a thin slotted screwdriver at the base of the connector and twist it slightly to pry up on the outer shell of the connector.

To insert the ribbon cable, hold the outer shell in the released position. Carefully insert the cable until all the “fingers” are below the surface of the shell. Push the shell to the locked position.

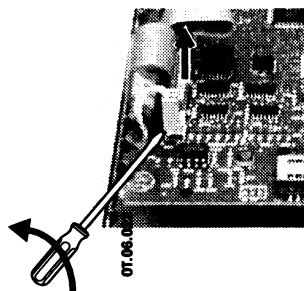

7.2.3 Battery and power supply

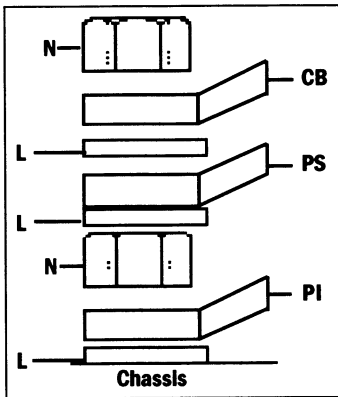

PI - Ground lug from Power Inlet
 PS - Ground lug from Power Supply
 CB - Ground lug from Control Board
 L - Lockwasher
 N - Keys nut

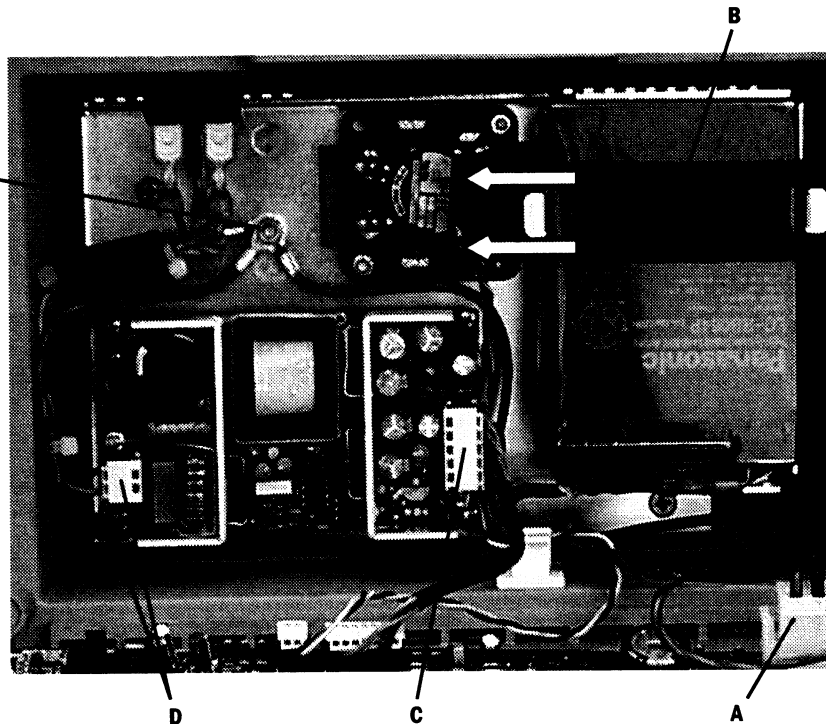

⚠ Caution

The circuit boards are electrostatic sensitive. Use an anti-static workstation and wear a wrist grounding strap when handling a circuit board.

To replace the Battery

Note: After replacement, the battery must be charged until Battery Status is indicated as "Battery Charged." Refer to Section 4.10.3.

1. Disconnect the battery cable (**A**) from the control board.
2. Note the orientation of the wires that connect to the battery and how they route through the retaining clamp.
3. Remove the battery's mounting strap (**B**)
4. Replace the battery in the same orientation noted above (wires facing inward).

To replace the Power Supply

1. Disconnect the battery cable (**A**) from the control board.
2. Disconnect the power supply's output connector (**C**).
3. Disconnect the power supply's input connector and ground wire (**D**).
4. Loosen each mounting screw (four corners) until it begins to ratchet.
5. Lift out the power supply.
6. Reassemble in reverse order.

Ground Terminal

Note the sequencing of ground wires and hardware when replacing any of the harnesses.

7.2.4 Front enclosure with control board removed

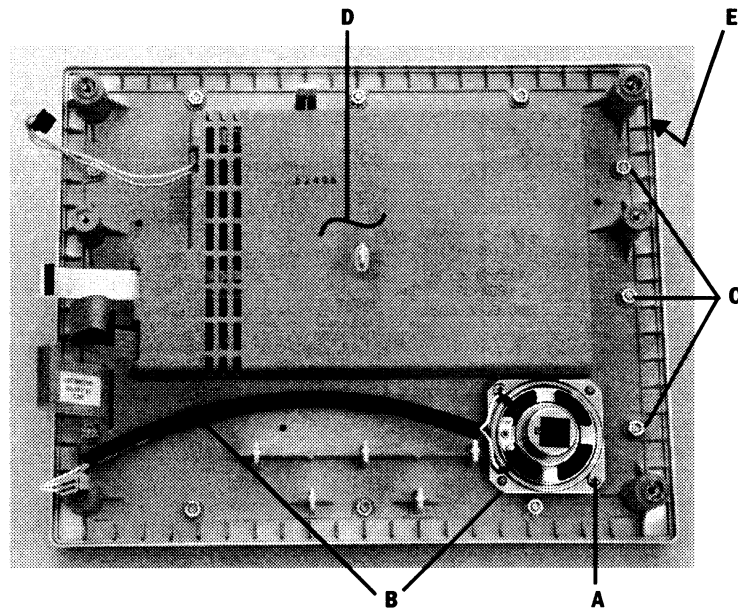

To replace the speaker

1. Remove the two screws (A) that hold the speaker assembly (B) to the front enclosure.
2. Reassemble in reverse order.

To remove the front enclosure

1. Use a 7-mm nut driver to remove the twelve nuts (C) around the periphery that hold the front enclosure (D) and the front panel assembly (E) together.
2. Carefully lift the front enclosure from the front panel assembly. Guide the cables through the slotted openings at the left edge of the front enclosure.
3. Reassemble in reverse order.

7.2.5 Front enclosure components

The front enclosure components include:

- The keyboard assembly (A)
- The LCD display assembly (B)
- The rotary encoder switch (C)

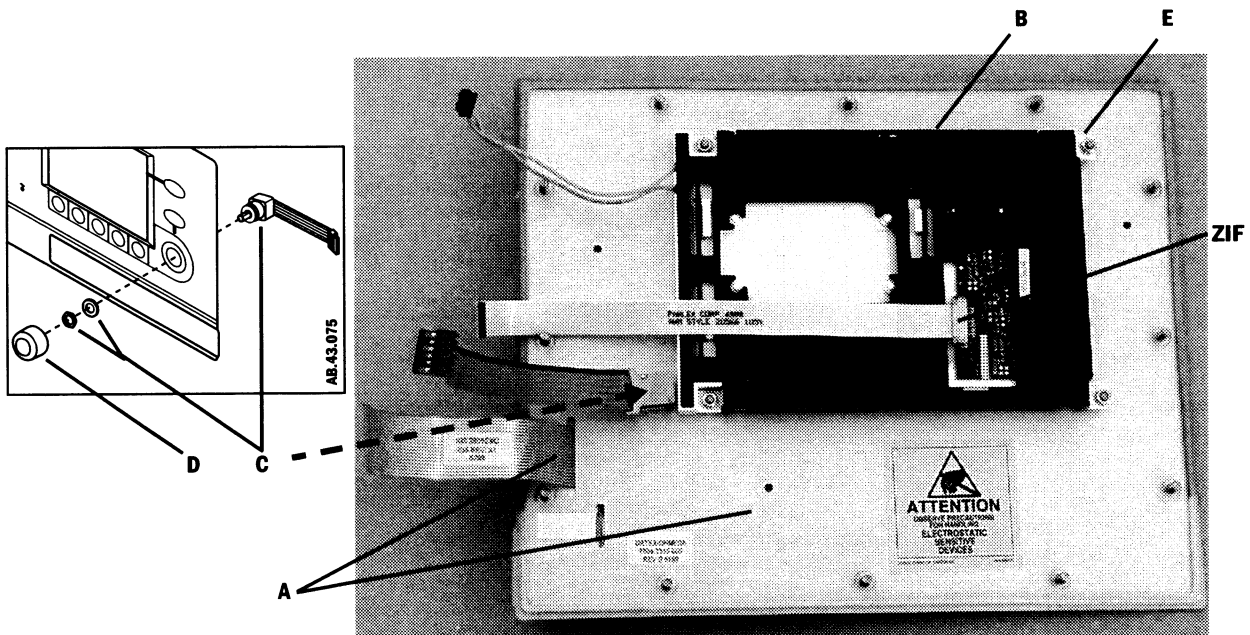

To replace the keyboard

The LCD display and the rotary encoder are mounted to the keyboard assembly. To replace the keyboard assembly you must transfer the LCD display and the rotary encoder to the new keyboard assembly.

To replace the rotary encoder

1. Pull the knob (D) off the shaft of the encoder.
2. Remove the nut and washer that hold the encoder to the keyboard.
3. Replace the encoder switch in reverse order. Note the orientation of the attached ribbon cable.

To replace the LCD display

1. Use a 5.5-mm nut driver to remove the four nuts (E) at each corner of the display.
2. Remove the display assembly from the keyboard.
3. If required, clean the keyboard window (if new, remove protective film).
4. Remove protective mask from new LCD display.
5. Transfer the spacers over the display mounting studs.
6. Mount the display to the keyboard studs.
7. Transfer the display ribbon cable (**contacts facing up**) to the new display (**ZIF connector**; pull tabs toward cable to release).

To replace the backlight

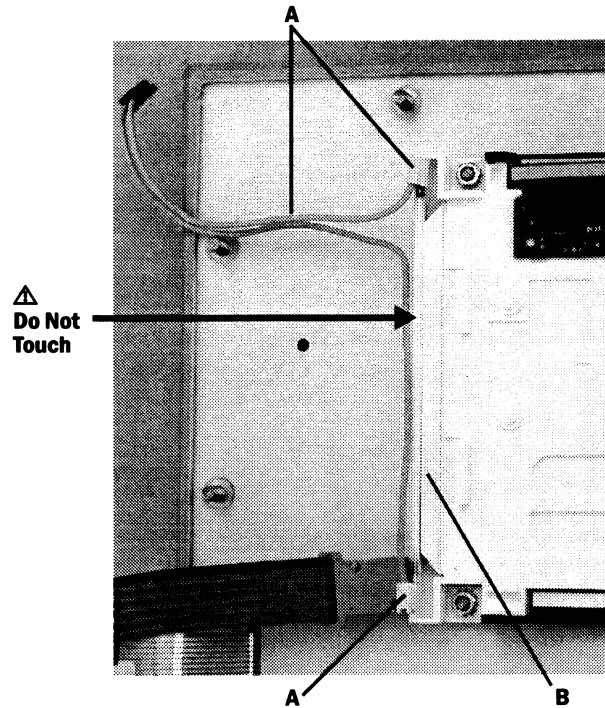

⚠ Caution Do not touch the glass portion of the backlight. Body oils or other contaminants can decrease the life of the backlight.

1. Remove the ribbon cable from the LCD display.
2. Remove the cover from the LCD display.
3. Carefully remove the backlight (**A**) from display assembly.
4. Guide the new backlight under the shielding flap (**B**) into the backlight cavity.
5. Replace the cover.
6. Replace the ribbon cable

7.3 Pneumatic engine

Refer to section 6 for pneumatic engine components that are to be serviced under regular maintenance. To service other components of the pneumatic engine, you must first remove it from the housing.

7.3.1 Pneumatic Engine In an Aestiva machine

In an Aestiva machine, the Pneumatic Engine is located in a housing at the rear of the breathing system.

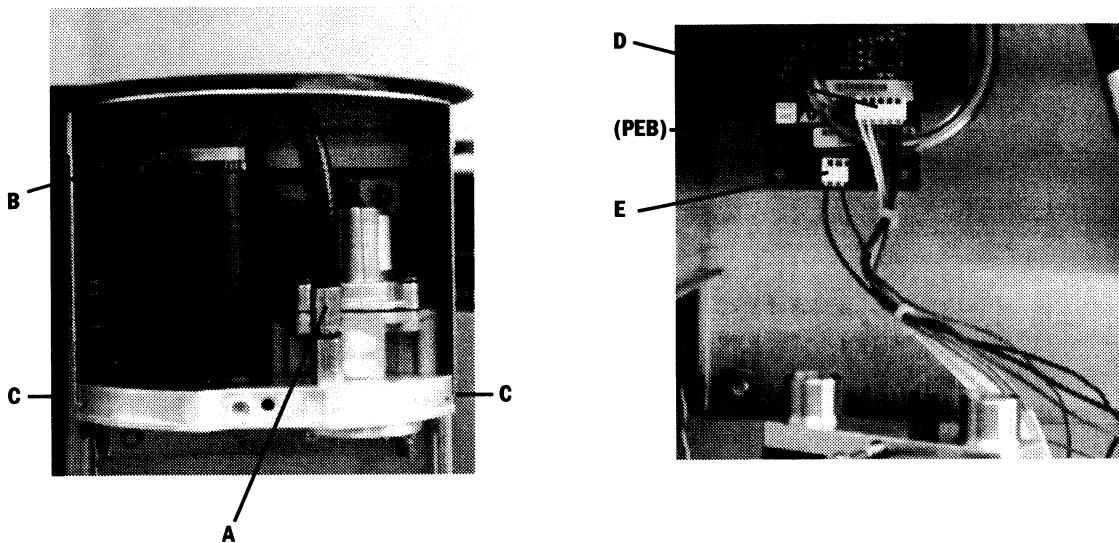

To remove the pneumatic engine

1. Disconnect pipeline supplies; close cylinder valves; bleed off pressure.
2. Remove the rear cover of the breathing system.
3. Disconnect the drive gas hose (A).
4. Loosen the dual tube riser mounting screw (B) until 3 or 4 treads show out of the riser block; pull down to lower the riser.
5. Remove the screws (C) that hold the engine manifold to the housing.
6. Slide the vent engine out of the housing just enough to access the harness connections at the Pneumatic Engine Board (PEB)
 - PEEP Valve, PEEP Safety Valve, and Supply Pressure Switch (D).
 - Inspiratory Flow Valve (E).
7. Remove the vent engine from the housing.
8. Reassemble in reverse order.

7.3.2 Pneumatic Vent Engine In an Aespire machine

In an Aespire machine, the pneumatic Vent Engine is located in a housing below the breathing system bellows.

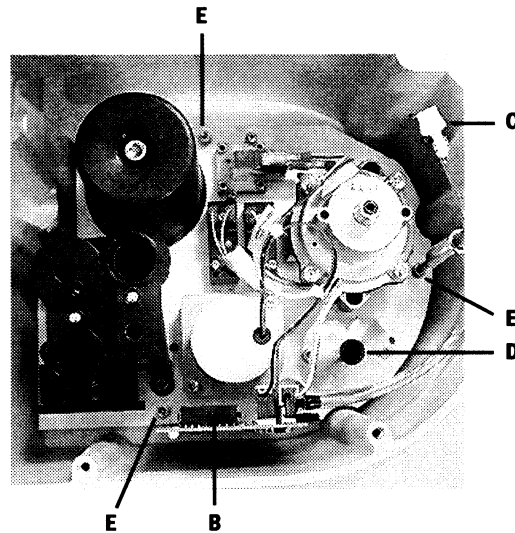
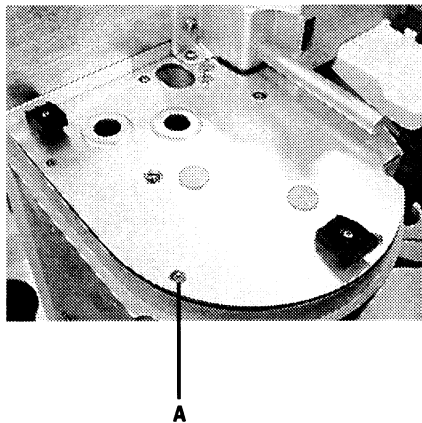

To remove the pneumatic engine

1. Disconnect pipeline supplies; close cylinder valves; bleed off pressure.
2. Remove the ABS breathing system.
3. Remove the Exhalation valve.
4. If present, remove the scavenging downtube.
5. Loosen the five captive screws (A) that hold the Vent Engine cover to the housing. Raise the cover to access the Vent Engine.
6. Disconnect the Vent Engine harness (B).
7. Disconnect the white tube-coupler (C) – inline with tube to pressure transducer on the Vent Engine Board.
8. If present, disconnect the black tube-coupler, inline with tube to scavenging.
9. Disconnect the drive gas hose (D).
10. Loosen the three captive screws (E) that hold the engine manifold to the housing.
11. Lift the Vent Engine out of the housing
12. Reassemble in reverse order.

7.3.3 Pneumatic engine components (Aespire machine)

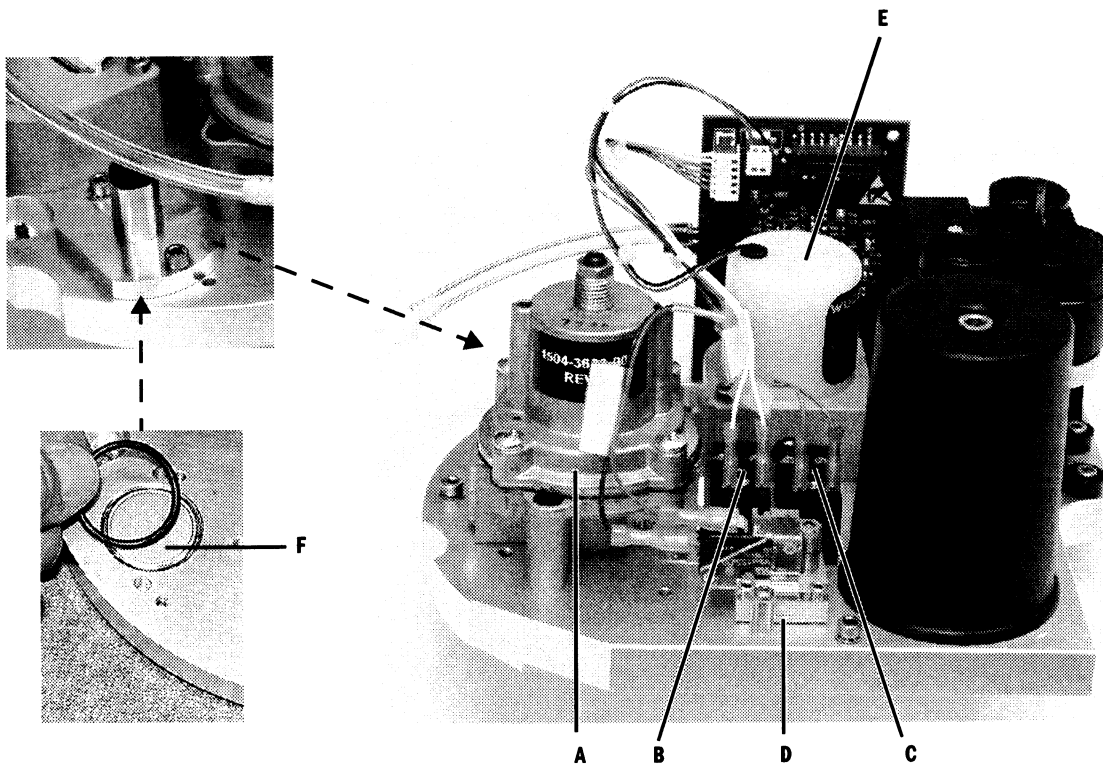

Regulator (A) Also inspect the two o-rings that seal it to the manifold. Replace as necessary.

PEEP Safety Valve (B) Ensure the valve you are installing (white dot) is in this location.

PEEP Valve (C) Ensure the valve you are installing (two blue dots) is in this location.

Supply Pressure Switch (D) Also inspect the o-ring that seal it to the manifold. Replace as necessary.
Transfer harness wire to top and middle tabs; bottom tab open.

Inspiratory Flow Valve (E) Note orientation of the flow valve. Also inspect the two o-rings that seal it to the manifold. Replace as necessary.

Inlet Filter (F) Install the filter (with the course side DOWN) into the recess in the manifold. Place the o-ring into its groove.

7.3.4 Pneumatic engine components (Aestiva machine)

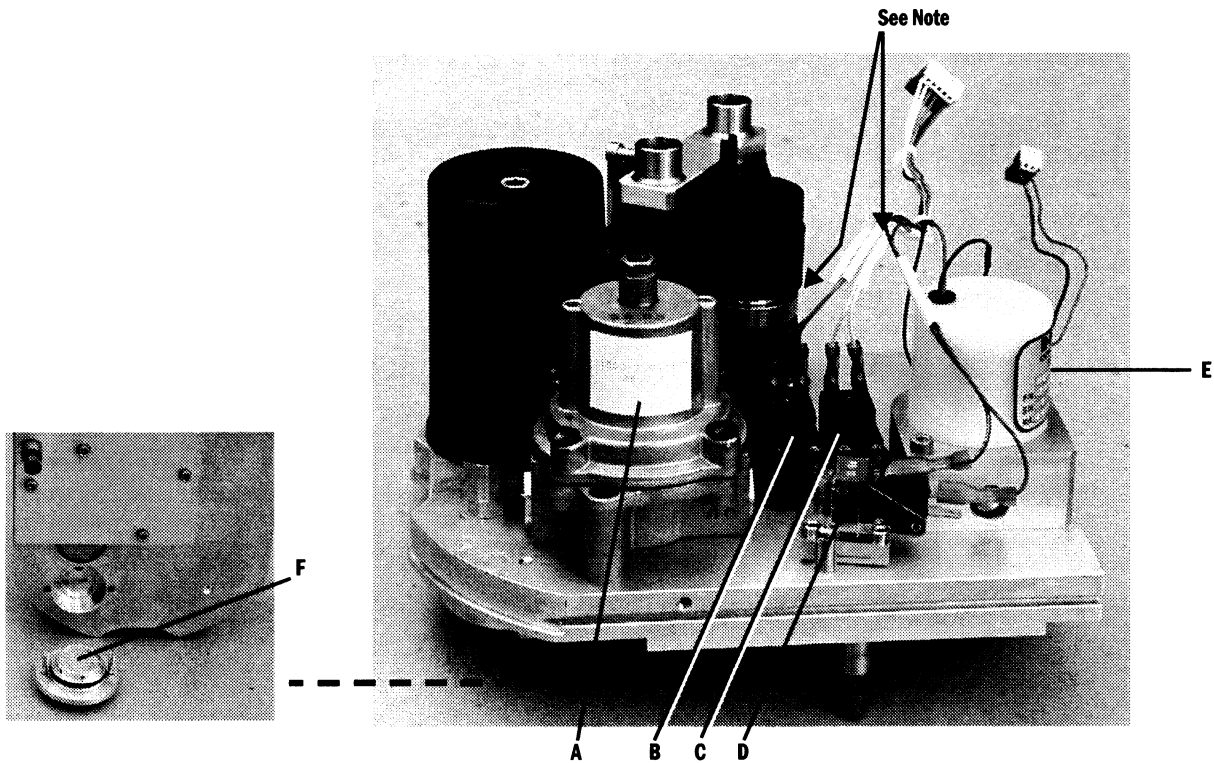

Regulator (A) Also inspect the two o-rings that seal it to the manifold. Replace as necessary.

PEEP Valve (B) Ensure the valve you are installing in this location is marked with two blue dots.

PEEP Safety Valve (C) Ensure the valve you are installing in this location is marked with a white dot.

Supply Pressure Switch (D) Also inspect the o-ring that seal it to the manifold. Replace as necessary.
Transfer harness wire to top and middle tabs; bottom tab open.

Inspiratory Flow Valve (E) Note orientation of the flow valve. Also inspect the two o-rings that seal it to the manifold. Replace as necessary.

Inlet Filter (F) Refer to Section 7.3.2, "Supply gas inlet filter."

Note The wire harnesses are tie-wrapped at this point to help keep the wires from interfering with the MOPV weight. If you cut the tie wrap when replacing the Inspiratory Valve or the PEEP Valve harness, be sure to tie-wrap the harnesses at the same point to ensure proper operation of the MOPV.

7.3.5 Supply gas inlet filter (Aestiva machine)

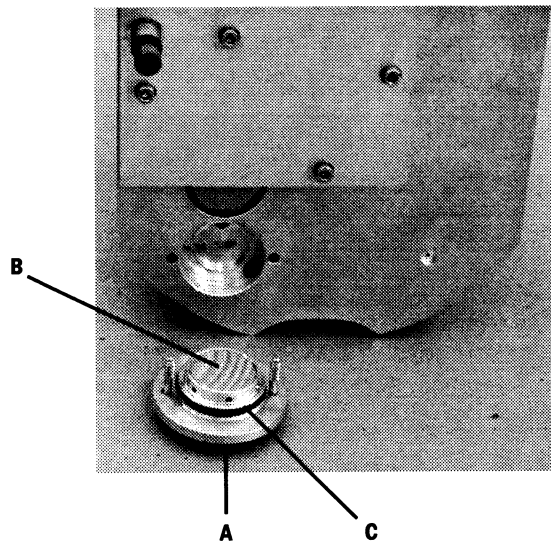

Note You can replace the inlet filter without completely removing the pneumatic engine. Before replacing the filter, be sure to observe the following:

- Disconnect pipeline supplies; close cylinder valves; bleed off pressure.
- Remove the AGSS receiver.

1. Remove the **filter retainer (A)** at the bottom of the vent engine.
 - Use a 3-mm hex wrench to loosen the retaining screw from the manifold.
 - Pull down on both screws to remove the filter retainer.
2. Pry the existing **2-micron filter (B)** from the retainer.
3. Install the new filter.
 - Place the filter screen on the retainer with the **coarse side up**.
 - With your thumb at the center of the screen, press the filter into place. Ensure that all of the filter is recessed below the outer rim.
4. Check the condition of the **o-ring (C)**. Replace if cracked or torn.
5. Reinstall the filter retainer.
6. Replace the AGSS receiver.

7.3.6 Insp/PEEP Interface assembly and reservoir

The illustration shows the Pneumatic Engine for an Aestiva machine. These components are (as are the other components) identical in the Vent Engine for an Aespire machine; however, in an Aespire machine, the Vent Engine does not include the dual-tube riser (A).

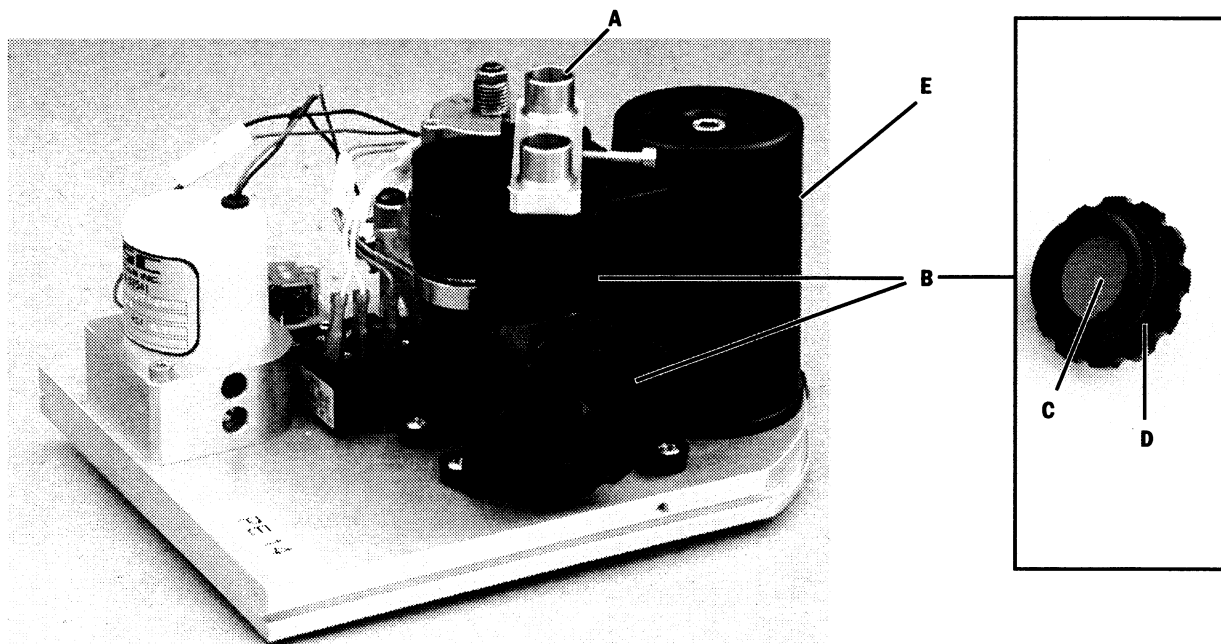

Insp/PEEP interface (B)

Also inspect the two o-rings, not shown, that seal it to the manifold. Replace as necessary.

If necessary, you can replace the free breathing valve components that are part of the Insp/PEEP interface (refer to the Maintenance Section 6.2. "Free breathing valve maintenance"):

- Free breathing valve flapper (C) and o-ring (D).
If necessary, clean flapper with alcohol before installing new; trim off flush with outside surface of seat (refer to the removed flapper).

Reservoir (E)

Also inspect the two o-rings, not shown:

- O-ring, reservoir to manifold
- O-ring, reservoir to screw head

7.3.7 Manifold and plate assembly

Aestiva machine

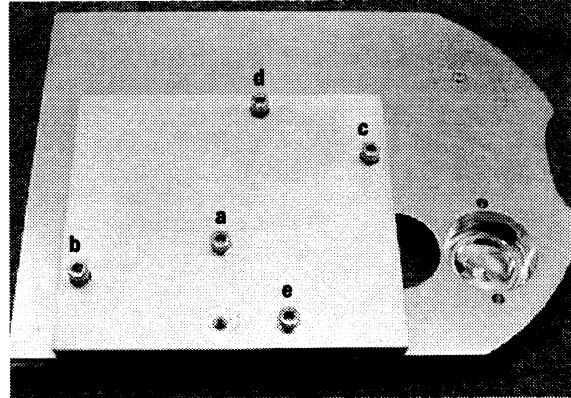
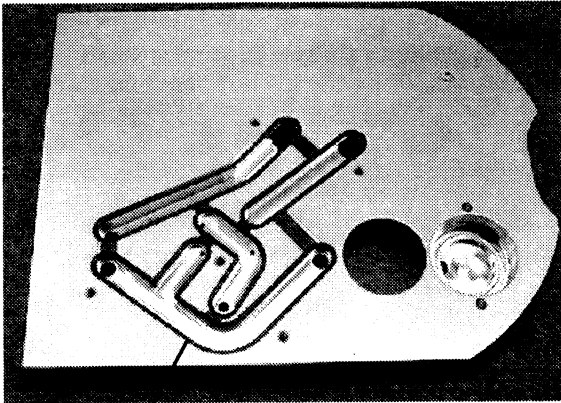

A

Manifold plate gasket (A)

1. Ensure that gasket is properly positioned.
2. Carefully install plate onto manifold making sure not to disturb the gasket.
3. Start all screws first.
4. Then, torque to 1.7 N-m (15 lb-in) using sequence shown.

Aespire machine

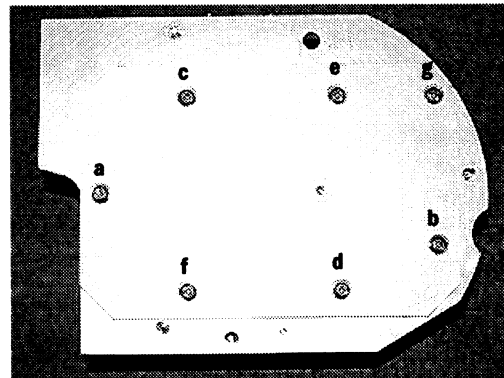
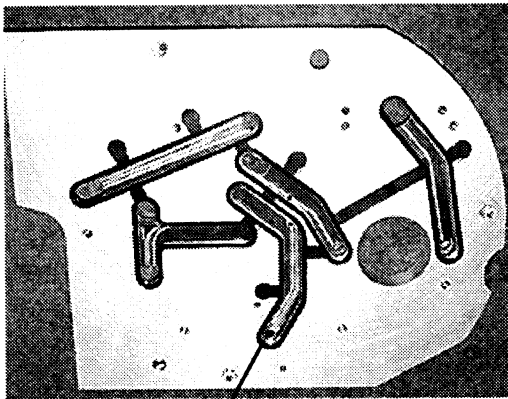

A

7.3.8 Pneumatic Engine Board and housing (Aestiva machine)

Note: In an **Aespire machine**, the Vent Engine Board is mounted directly to the Vent Engine manifold. Refer to the Aespire machine Technical Reference Manual for details.

To remove the Pneumatic Engine Board and housing in an **Aestiva machine**, you must first remove the rear subfloor of the breathing system. Remove the following:

- Flow sensors, patient circuit, bag arm, open control panel, bellows assembly, main manifold, exhalation valve, and rear subfloor.

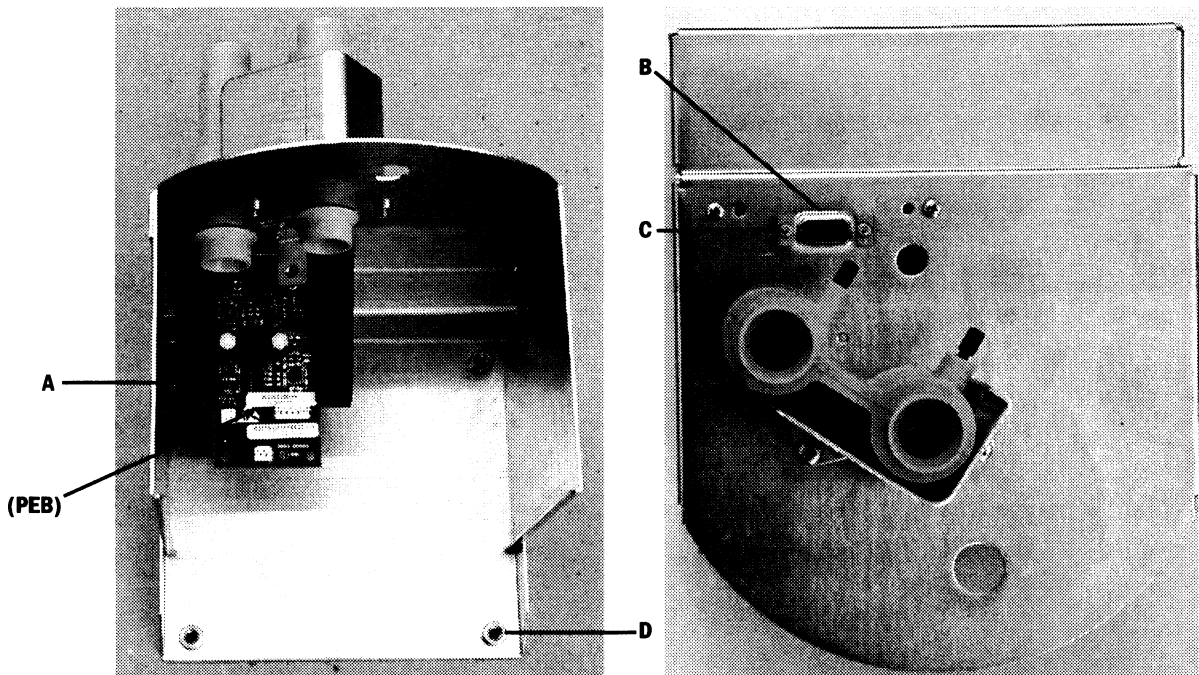

Pneumatic Engine Board (PEB)

You can replace the PEB without removing the housing.

1. Disconnect tubing from pressure transducer (A).
2. Disconnect the control module cable (B) from the top of the PEB.
3. Loosen the PEB mounting screws (C) until you can slide the PEB down out of the guides. Note, the mounting screws require a 3/32-inch hex wrench.
4. Reassemble in reverse order.

Pneumatic Engine Housing

To replace the housing:

1. Disconnect tubing from pressure transducer (A).
2. Disconnect the control module cable (B) from the top of the PEB.
3. Pull the drive gas hose and the pressure transducer tubing into the rear subfloor area.
4. Remove the components in the absorber canister area:
 - the canisters, the upper and lower canister dish assembly, and the down tube
5. Remove the four screws (D) that hold the housing to the lower chassis of breathing system.
6. Reassemble in reverse order.

7.4 Monitoring Interface Assembly (MIA) in an Aestiva machine

Note: This section applies only to an **Aestiva machine**. For an **Aespire machine**, refer to the Aespire machine Technical Reference Manual for details about the Ventilator Monitoring Board.

The MIA is located in the breathing system, below the front and rear subfloors. It is held in place by the bulkhead. If you are not familiar with this area, refer to the service manual for the Aestiva anesthesia machine.

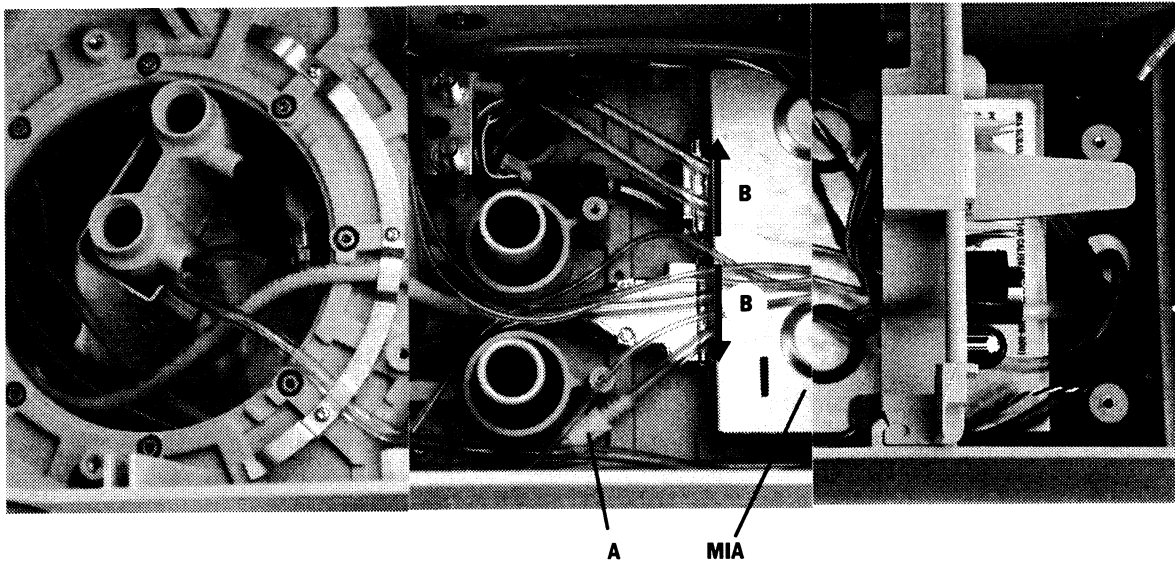

To replace the Monitoring Interface Assembly (MIA)

1. Remove the following items to gain access to the subfloor area:
 - Flow sensors, breathing circuit, bag arm, open control panel, bellows assembly, main manifold, and the exhalation valve.
2. Remove the front and rear subfloors.
3. Remove the bulkhead cover.
4. Disconnect the pressure gauge tubing; disconnect the control panel harness; remove the control panel.
5. Disconnect the four inline tubing connectors (**A**) between the MIA and the bulkhead connector.
6. Disconnect the cables at the rear of the MIA. Slide the cable retainer (**B**) on each connector toward the outside of the breathing system (away from each other).
7. Remove the two bulkhead mounting screw from below the breathing system chassis.
8. Raise the bulkhead to release the MIA. The MIA is secured with Velcro on the bottom.
9. Move the MIA backwards for easier access to the front cable connectors.
10. Disconnect the cables at the front of the MIA.
 - Cable from O₂ sensor (release latch at bottom of connector).
 - If present, cable from ACGO switch (release latch at top of connector)
11. Reassemble in reverse order.

⚠ Caution

Position each component carefully so that you do not pinch any of the tubing or wiring.

7.5 Serial Adapter Board (SAB) and Power Cord/Harness

Note: This section applies only to an **Aestiva machine**. For an **Aespire machine**, refer to the Aespire Technical Reference Manual for details about the Serial Isolation and Connector Board.

The SAB is located in the electrical enclosure area behind the AC Inlet module. The two cables that connect to the MIA are behind the rear panel in the pneumatics area.

⚠ **WARNING** Disconnect the power cord from the wall before attempting to remove or repair any circuit board to avoid shock hazard.

⚠ **WARNING** The AC inlet module is very heavy. Use caution when removing it from the anesthesia enclosure.

⚠ **Caution** The circuit boards are electrostatic sensitive. Use an anti-static workstation and wear a wrist grounding strap when handling a circuit board.

To gain access to the Serial Adapter Board

1. Remove the AC inlet module from the rear of the Aestiva Anesthesia Machine.
 - a. Loosen the two captive M4 screws.
 - b. Pulling on the two captive screws, cautiously slide the AC inlet module out only halfway from the enclosure. Use the two side handles (cutouts in the sheet metal) to lift out the AC inlet module from the enclosure.

⚠ **WARNING** The AC inlet module is very heavy. Use caution when removing it from the anesthesia enclosure.

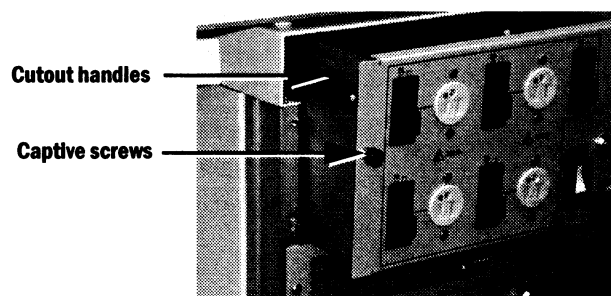

2. Remove the electronics compartment cover by removing the four Phillips head screws (two along top edge, one along each side).
3. Remove the rear panel (see Section 4.1.1 of the Aestiva Anesthesia Machine Service Manual).

To replace the Serial Adapter Board

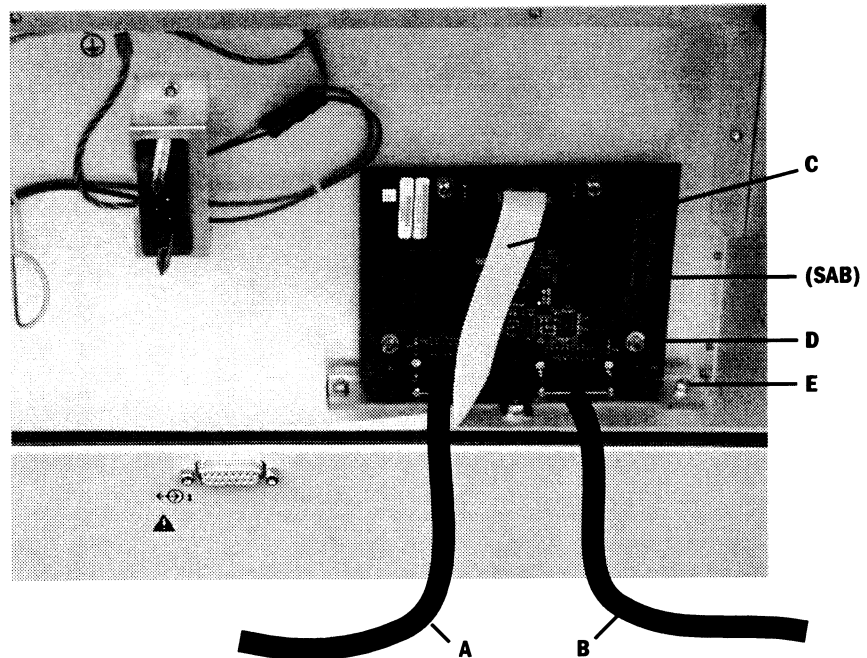

1. Disconnect the two cables from the bottom of the SAB:
 - Cable (A) from machine switches (system switch, O₂ flush, O₂ supply).
 - Cable (B) from control module.
2. Disconnect the serial output cable (C).
3. Remove the three screws (D) that hold the SAB to the back wall.
4. Remove the three nuts (E) that hold the SAB mounting bracket to the enclosure.
5. Reassemble in reverse order.

**To replace
the power cord/harness**

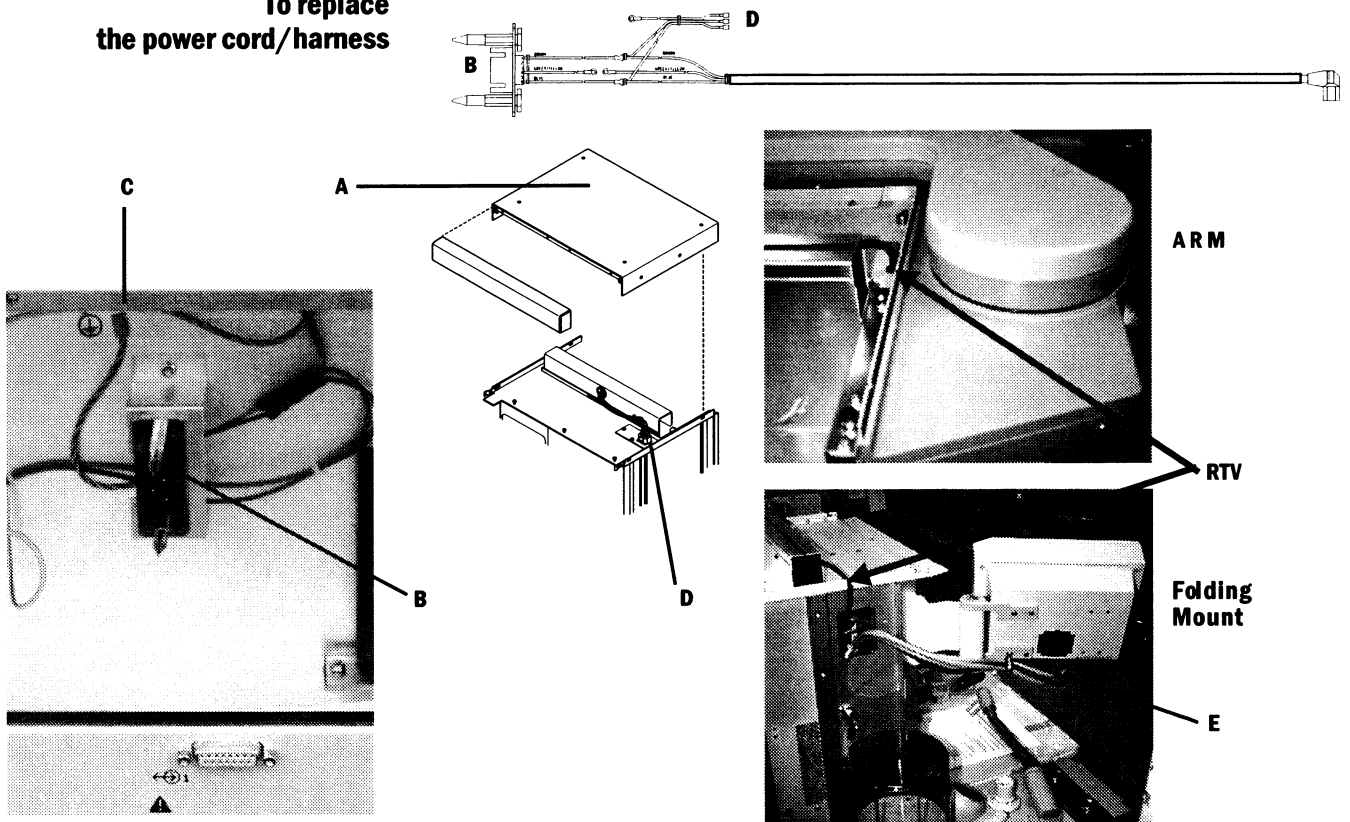

1. Remove the top shroud (A) (refer to Aestiva Machine Service Manual).
2. Remove the harness connector (B) from mounting bracket.
3. Disconnect the ground wires (C).
4. Disconnect the wires from the Tec 6 outlet (D).
5. Disconnect the power cord from the control module (E).
6. **For machines with Display Arm**, disassemble arm to gain access to routing for power cord
 - Remove cover at end of arm.
 - Remove top cover of arm.
 - Remove front and back plates from shoulder.
 - Loosen shoulder mounting screws enough to form gap at top large enough to pass the power plug connector.
7. **For machines with Folding Mount**, remove the side panel.
7. Pull the power cord into the electrical enclosure.
8. Reassemble in reverse order.
9. Apply **RTV** where the cord enters the machine area from the top.

8 Illustrated Parts

In this section

This section contains assembly illustrations for easier identification of parts as they are disassembled. The 7100 Ventilator components are found in various locations of the anesthesia machine as detailed in the respective Technical Reference manual.

8.1 Special instructions	8-2
8.2 Service tools	8-2
8.3 7100 Ventilator parts	8-3

8.1 Special instructions

Apply a thin coat of oxygen-use-approved lubricant to o-rings prior to installation (unless otherwise noted). Use:

- Krytox GPL 205,
Datex-Ohmeda stock number 1001-3854-000

Some screws require an anti-loosening bond. Use:

- Loctite #24231, screw lock,
Datex-Ohmeda stock number 0220-5016-300

When you replace fittings, position the barb end in the same direction as the original fitting to make hose connections easier.

8.2 Service tools

Item	Tool		Stock Number	Reference
1	Software Memory Stick, SW Revision 1.3		1504-8130-000	Section 7.1 Software Installation
2	PEEP/INSP Calibrated Flow Orifice Note: The Calibrated Flow Orifice for the Aespire has the same orifice size as the Calibrated Flow Orifice for the Aestiva; however, the Aestiva orifice has a larger outside dimension that does not fit through the Vent Engine cover plate. To use the Aestiva orifice with an Aespire machine, you must remove the cover plate to access the manifold port. The Aespire orifice will work for both the Aestiva machine and the Aespire machine.	2a for Aestiva 2b for Aespire	1504-3005-000 1504-3016-000	Section 4.9.4 Airway Sensor Span (and others).
3	Airway Pressure Sensing Tee		1504-3011-000	Section 4.9.4 Airway Sensor Span

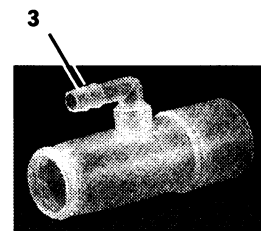
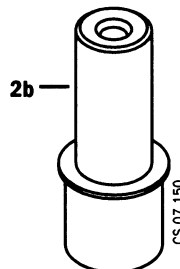
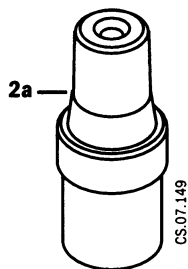
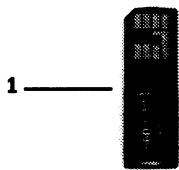

8.3 7100 Ventilator parts

	Description	
Figure 8-1	Display Assembly.....	Page 8-4
Figure 8-2	Display components	Page 8-5
Figure 8-3	Display, front cover assembly	Page 8-6
Figure 8-4	Display Keyboard and LCD assembly.....	Page 8-7
Figure 8-5	Pneumatic Engine, view 1 of 2 (Aestiva machine).....	Page 8-8
Figure 8-6	Pneumatic Engine, view 2 of 2 (Aestiva machine).....	Page 8-9
Figure 8-7	Pneumatic Vent Engine, view 1 of 2 (Aespire machine)	Page 8-10
Figure 8-8	Pneumatic Vent Engine, view 2 of 2 (Aespire machine)	Page 8-11
Figure 8-9	Manifold plate (Aestiva machine).....	Page 8-12
Figure 8-10	Manifold plate (Aespire machine).....	Page 8-12
Figure 8-11	Mounting Bracket, pneumatic engine (Aestiva machine).....	Page 8-13
Figure 8-12	Serial Adapter Board (Aestiva machine)	Page 8-14
Figure 8-13	Subfloor components (Aestiva machine).....	Page 8-15

7100 Anesthesia Ventilator

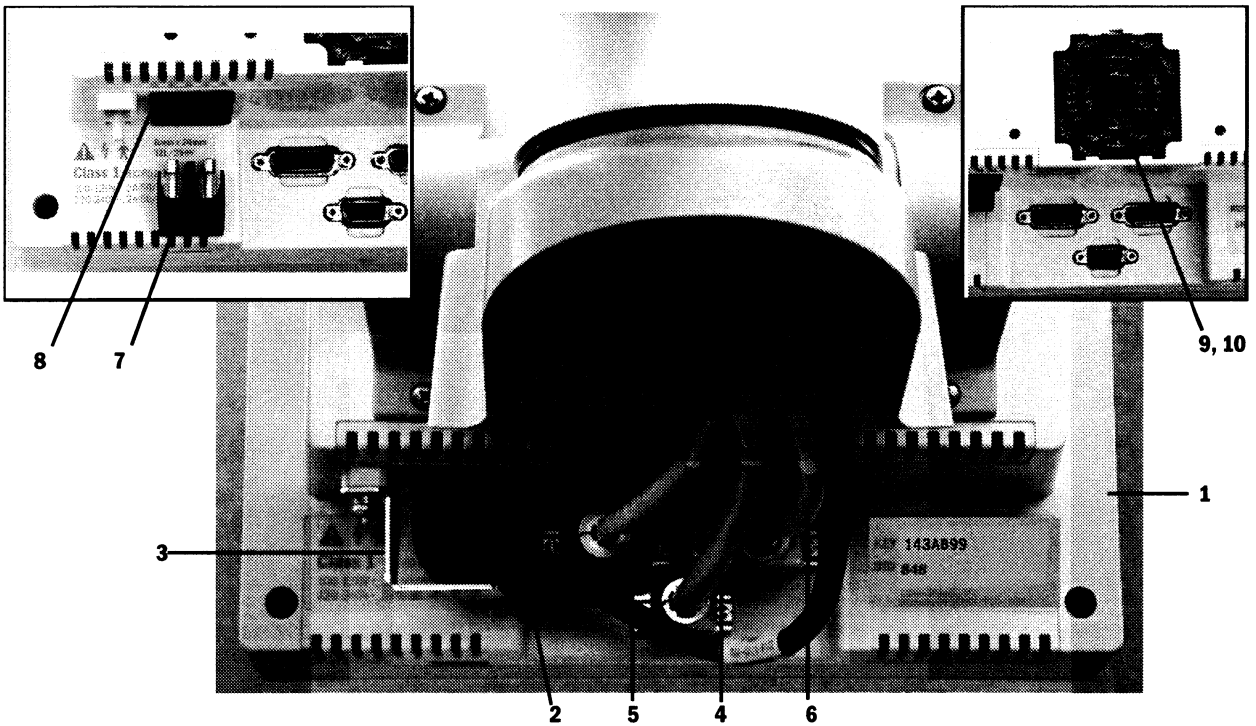

Figure 8-1 ▪ Display Assembly (shown on Aestiva arm)

Item	Description	Stock Number
1*	Control Module	1504-8500-000
2	Power Cord - Aestiva machine Power Cord - Aespire machine	1504-5705-000 1009-5711-000
3	Retainer, power cord	1504-3503-000
4	Cable, pneumatic engine	1504-5605-000
5	Cable, serial adapter board - Aestiva machine Cable, serial isolation and connector board - Aespire machine	1504-5606-000 1009-5691-000
6	Cable, monitoring interface assembly	1504-5604-000
7	Fuse, inline 2A time delay, T2L/250V, 5mm x 20mm	1503-3073-000
8	AC Inlet, double pole snap-in	1504-3515-000
9	Filter, fan	1504-3519-000
10	Retainer, fan filter	1504-3518-000
<p>* Also order appropriate revision Software Memory Stick.</p> <ul style="list-style-type: none"> ▪ Refer to Section 8.2 for Stock Number. ▪ Refer to Section 7.1.1 for instructions regarding a replaced Control Board or Control Module 		

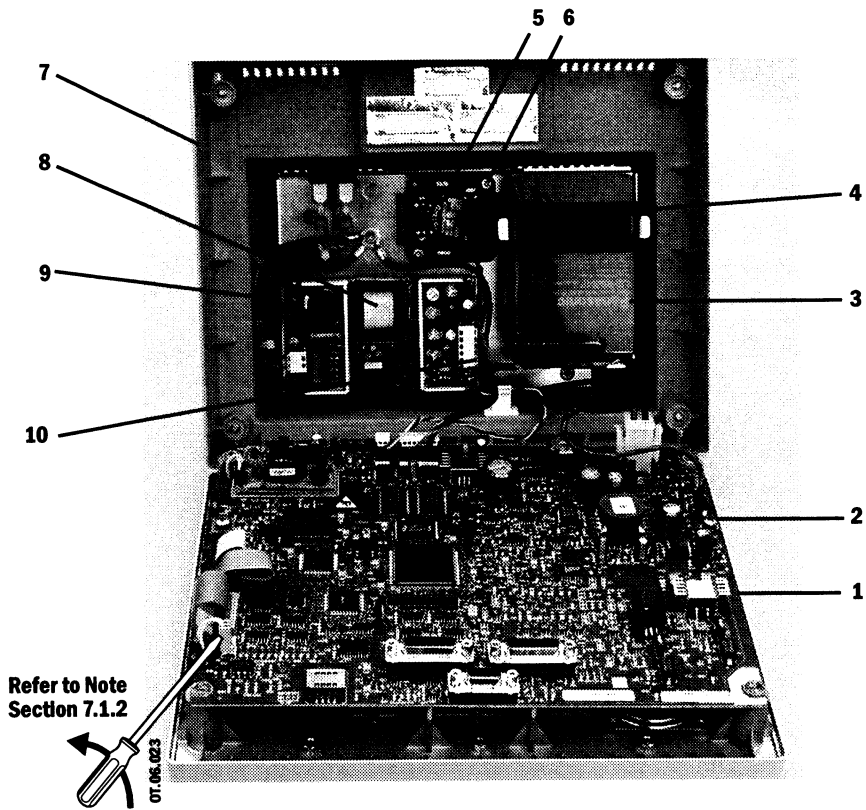

Figure 8-2 • Display components

Item	Description	Stock Number
1*	Control Board	1504-8507-000
2	Screw, M4x8 SEMS	0140-6226-113
3	Battery, 6 V 4 AH sealed lead acid	1504-3505-000
4	Strap, battery retainer	1504-3509-000
5	Fan, 5 VDC	1504-3516-000
6	Nut, M3 KEPS	0144-3717-302
7	Enclosure, rear	1504-8506-000
8	Power Supply, Universal 40W	1504-3520-000
9	Harness, power AC	1504-5613-000
10	Harness, power DC	1504-5614-000
<p>* Also order appropriate revision Software Memory Stick.</p> <ul style="list-style-type: none"> ▪ Refer to Section 8.2 for Stock Number. ▪ Refer to Section 7.1.1 for instructions regarding a replaced Control Board or Control Module 		

7100 Anesthesia Ventilator

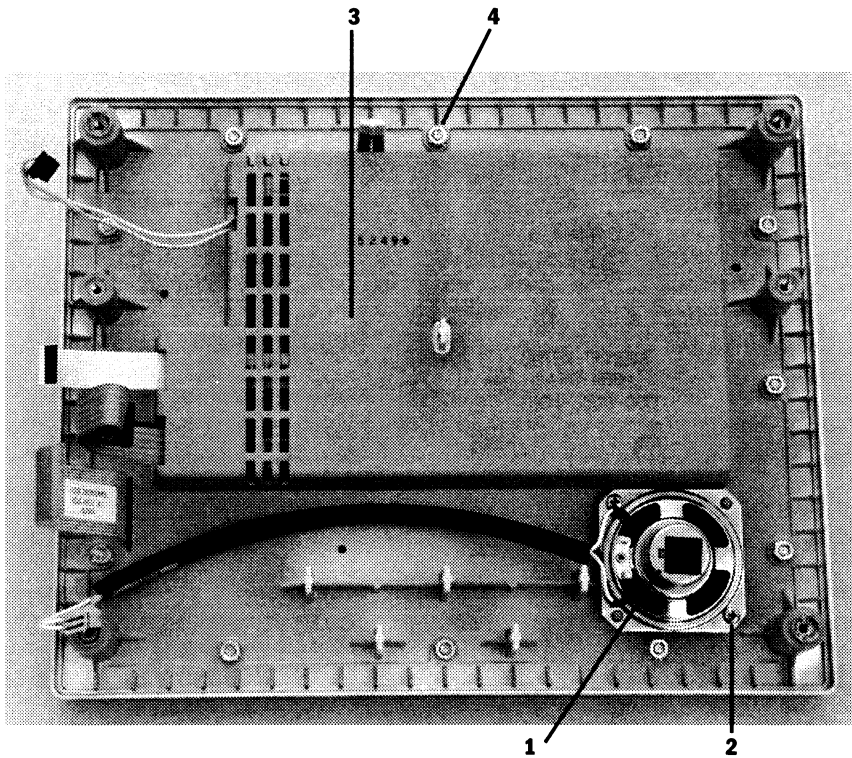

Figure 8-3 • Display, front cover assembly

Item	Description	Stock Number
1	Speaker, with harness	1504-3513-000
2	Screw, M3	0140-6219-128
3	Enclosure, front	1504-3500-000
4	Nut, M4 KEPS	0144-3717-314

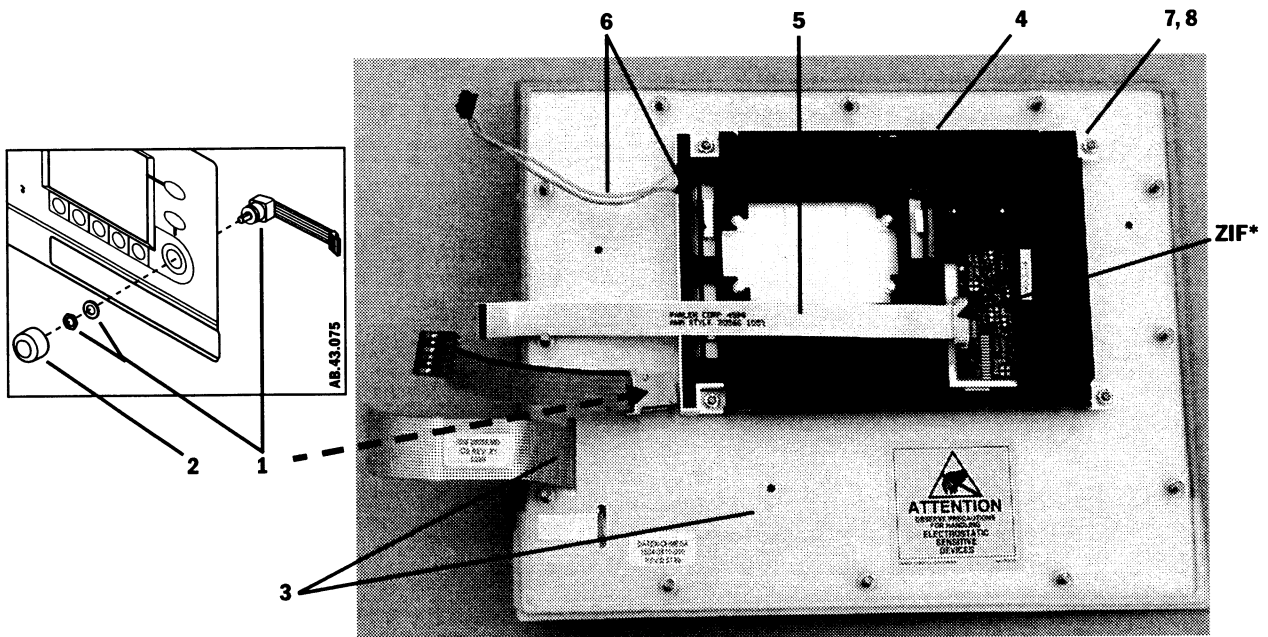

Figure 8-4 • Display Keyboard and LCD assembly

Item	Description	Stock Number
1	Rotary Encoder, switch	1503-3012-000
2	Knob, soft touch	1006-4622-000
3	Keyboard, front panel	1504-3534-000
4	Display, LCD 320x240 (includes backlight)	1504-3507-000
5	Display Cable, flat flex	1504-5602-000
6	Backlight (Refer to Section 7.2.5, "To replace the backlight.")	1504-8509-000
7	Spacer	1504-3525-000
8	Nut, M3 KEPS	0144-3717-302
* ZIF connector; pull tabs toward cable to release.		

7100 Anesthesia Ventilator

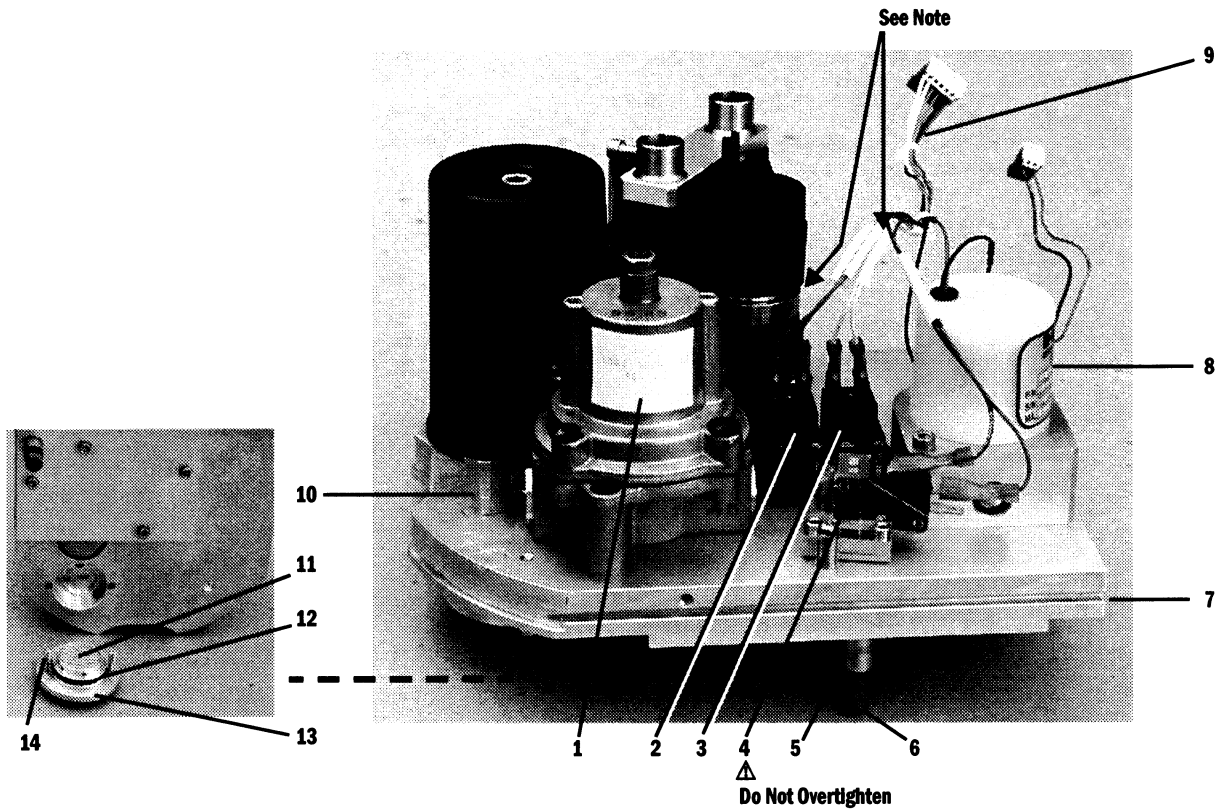

Figure 8-5 • Pneumatic Engine, view 1 of 2 (Aestiva machine)

Item	Description	Stock Number
	Pneumatic Engine Assembly, Service-Aestiva machine	1504-8503-000
1	Regulator O-ring, 9.25 ID x 12.8 OD (2)	1504-3623-000 1503-3056-000
2	PEEP Valve (blue dot)	1504-3610-000
3	PEEP Safety Valve (white dot)	1504-3608-000
4	Pressure Sense Switch O-ring, 3.63 ID x 8.87 OD	1504-3607-000 1006-4156-000
5	Fitting, 6.35-mm (1/4-inch)	1504-3621-000
6	Plug, 6.35-mm (1/4-inch)	1503-3245-000
7	Manifold Plate Assembly	See Figure 8-7
8	Inspiratory Flow Control Valve O-ring, 9.25 ID x 12.8 OD (2)	1504-3620-000 1503-3056-000
9	Harness, valve switches	1504-5700-000
10	Fitting, 8-mm Drive Gas	1504-3618-000
11	Filter, 2-micron (install course side UP)	1504-3708-000
12	O-ring, 28.24 ID 33.48 OD	1504-3612-000
13	Retainer, filter	1504-3707-000
14	Screw, M4x20 SKT HD CAP Lockwasher, M4 internal	1503-3105-000 0144-1118-128

Note: The wire harnesses are tie-wrapped at this point to help keep the wires from interfering with the MOPV weight. If you cut the tie wrap when replacing the Inspiratory Valve or the PEEP Valve harness, be sure to tie-wrap the harnesses at the same point to ensure proper operation of the MOPV.

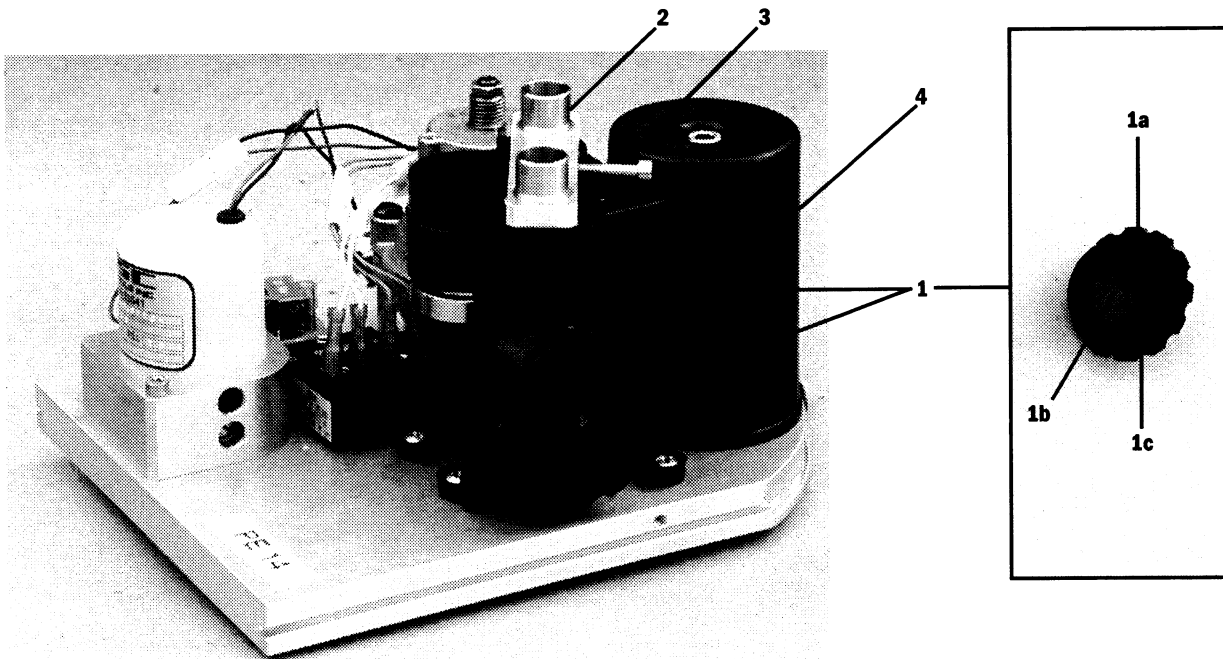

Figure 8-6 • Pneumatic Engine, view 2 of 2 (Aestiva machine)

Item	Description	Stock Number
1	Interface Manifold, pneumatic engine (with free breathing valve and mechanical overpressure valve) O-ring, 12.42 ID x 15.98 OD (2)	1504-8505-000 1406-3536-000
	a - Seat, free breathing valve	1503-3204-000
*	b - Valve, flapper	0211-1454-100
	c - O-ring	1503-3208-000
2	Riser, dual tube	1504-3705-000
3	Screw, M4x30 CAP HD	9211-0640-304
4	Reservoir, pneumatic engine O-ring, base, 56.87 ID x 60.43 OD O-ring, screw head, 0.219 ID x 0.344 OD	1504-3704-000 1504-3614-000 0210-0686-300
* If necessary, clean with alcohol before installing new; trim off flush with outside surface of seat (refer to removed flapper).		

7100 Anesthesia Ventilator

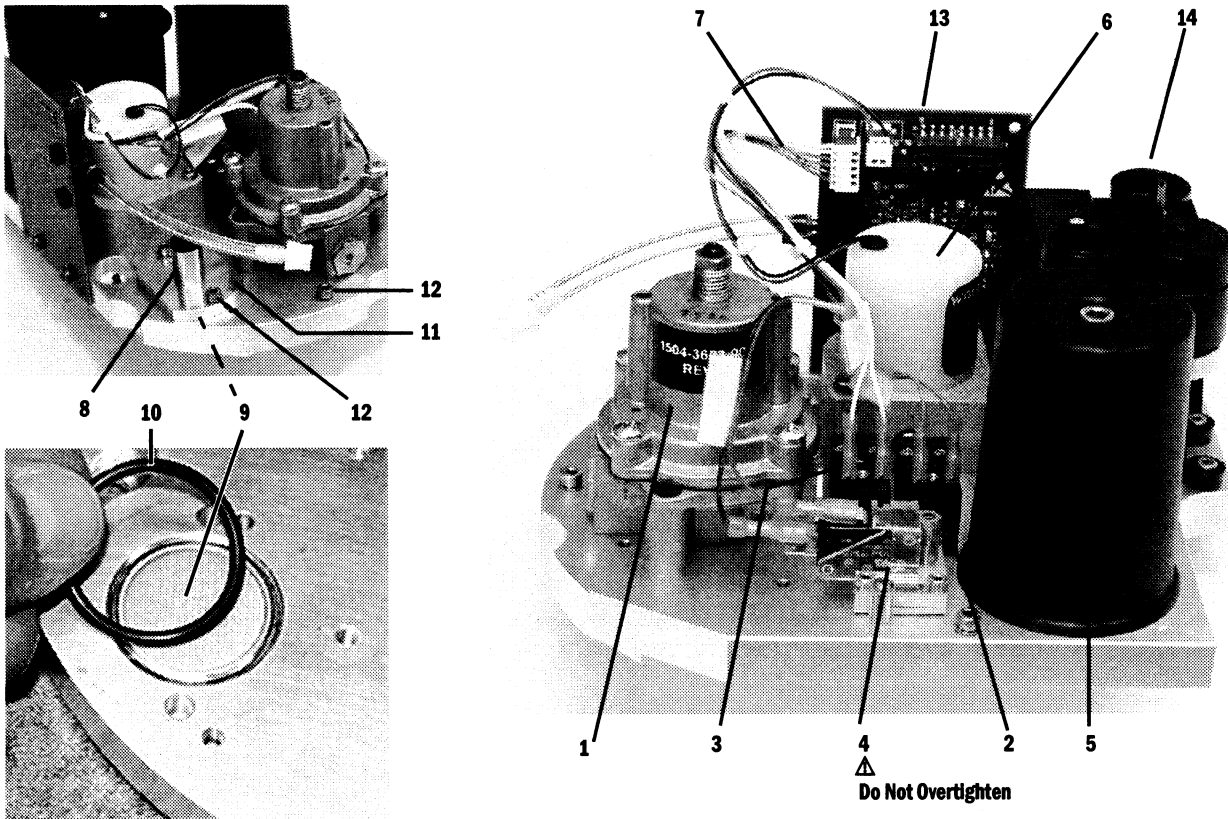

Figure 8-7 • Pneumatic Vent Engine, view 1 of 2 (Aespire machine)

Item	Description	Stock Number
	Pneumatic Engine Assembly, Service-Aespire machine	1009-8000-000
1	Regulator O-ring, 9.25 ID x 12.8 OD (2)	1504-3623-000 1503-3056-000
2	PEEP Valve (blue dots)	1504-3610-000
3	PEEP Safety Valve (white dot)	1504-3608-000
4	Pressure Sense Switch O-ring, 3.63 ID x 8.87 OD	1504-3607-000 1006-4156-000
5	Reservoir, pneumatic engine O-ring, base, 56.87 ID x 60.43 OD O-ring, screw head, 0.219 ID x 0.344 OD	1504-3704-000 1504-3614-000 0210-0686-300
6	Inspiratory Flow Control Valve O-ring, 9.25 ID x 12.8 OD (2)	1504-3620-000 1503-3056-000
7	Harness, valve switches	1504-5700-000
8	Fitting, 8-mm Drive Gas	1504-3618-000
9	Filter, 2-micron (Install course side DOWN)	1504-3708-000
10	O-ring, 28.24 ID 33.48 OD	1504-3015-000
11	Retainer, filter	1504-3718-000
12	Screw, M4x20 SKT HD CAP Lockwasher, M4 internal	1503-3105-000 0144-1118-128
13	Vent Engine Board (not part of assembly)	Refer to Figure 8-8 •
14	Interface Manifold	Refer to Figure 8-8 •

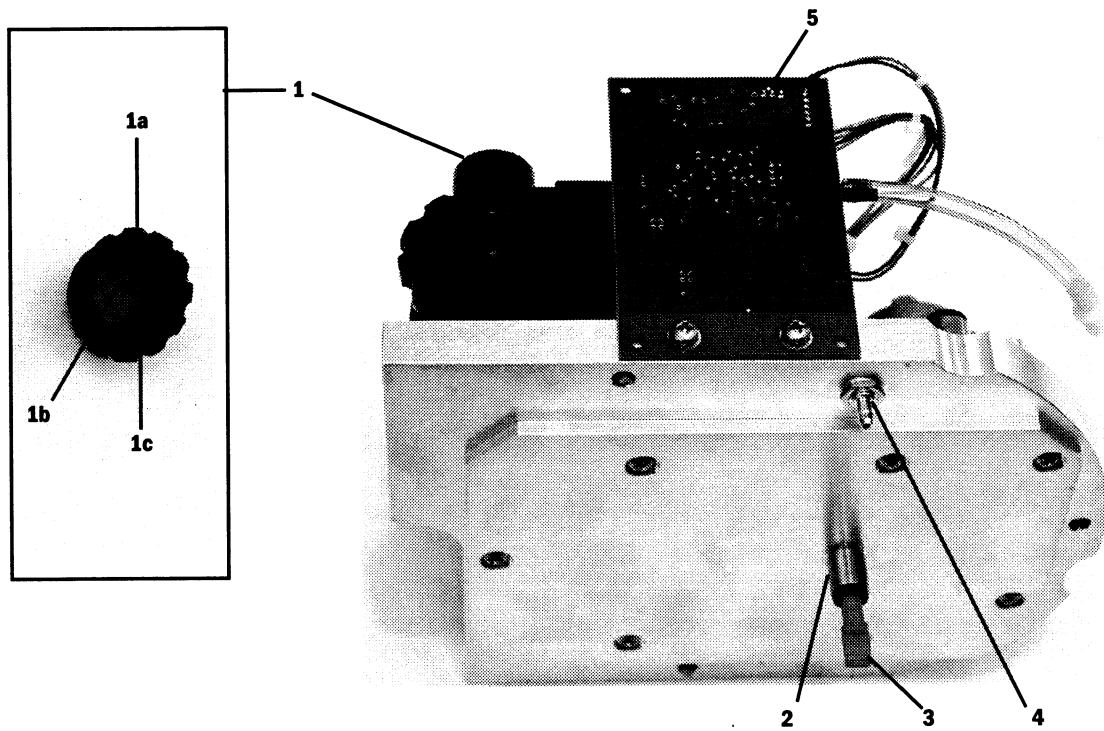

Figure 8-8 ▪ Pneumatic Engine, view 2 of 2 (Aespire machine)

Item	Description	Stock Number (Aespire)
1	Interface Manifold, pneumatic engine (with free breathing valve and mechanical overpressure valve) O-ring, 12.42 ID x 15.98 OD (2)	1504-8505-000 1006-3615-000
	a - Seat, free breathing valve	1503-3204-000
*	b - Valve, flapper	0211-1454-100
	c - O-ring	1503-3208-000
2	Fitting, 6.35-mm (1/4-inch)	1504-3621-000
3	Plug, 6.35-mm (1/4-inch)	1503-3245-000
4	Fitting, barbed	1504-3014-000
5	Vent Engine Board (not part of assembly)	1009-8001-000
* If necessary, clean with alcohol before installing new; trim off flush with outside surface of seat (refer to removed flapper).		

Aestiva machine

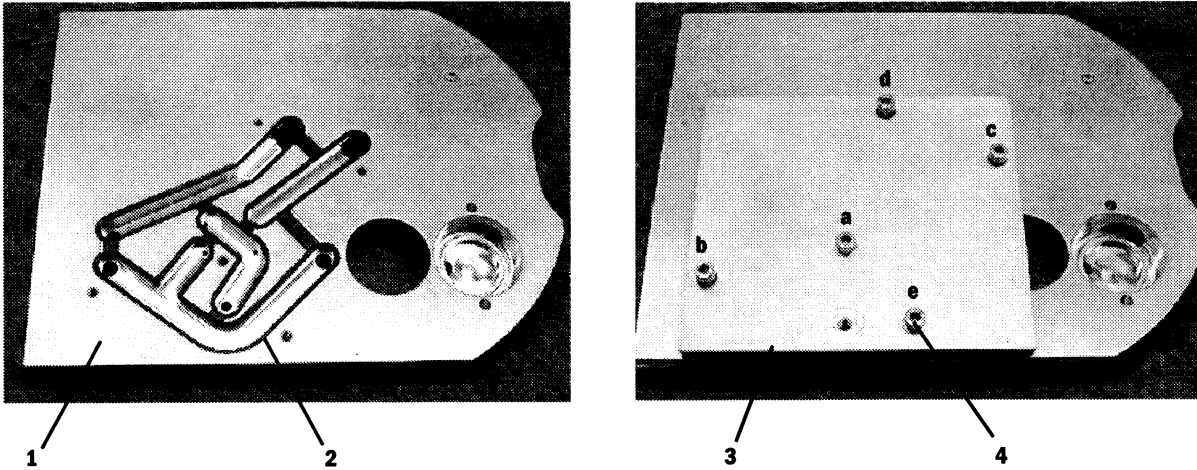

Figure 8-9 • Manifold plate for an Aestiva machine

Item	Description	Stock Number
1	Manifold – Aestiva machine Manifold – Aespire machine	1504-8504-000 1504-3715-000
2*	Gasket, manifold – Aestiva machine Gasket, manifold – Aespire machine	1504-3711-000 1504-3717-000
3	Plate, manifold – Aestiva machine Plate, manifold – Aespire machine	1504-3712-000 1504-3716-000
4**	Screw, M4x12 Lockwasher, M4 internal	1102-3006-000 0144-1118-128
5**	Screw, M4x8 Pozidriv PAN	1006-3178-000

* Install gasket into manifold. Check to see that it is properly positioned.
 ** Carefully install plate onto manifold making sure not to disturb the gasket. First, start all screws. Then, torque to 1.7 N·m (15 lb-in) using sequence shown.

Aespire machine

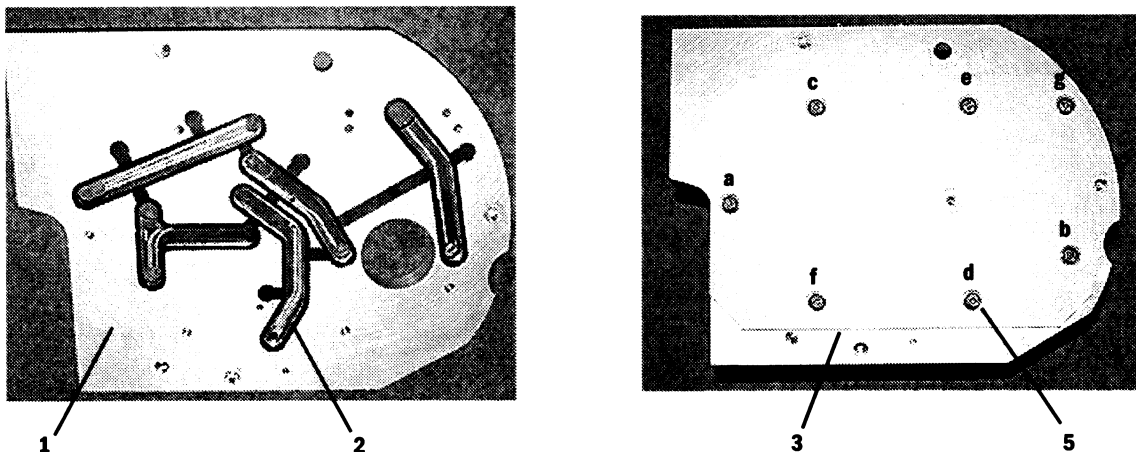

Figure 8-10 • Manifold plate for an Aespire machine

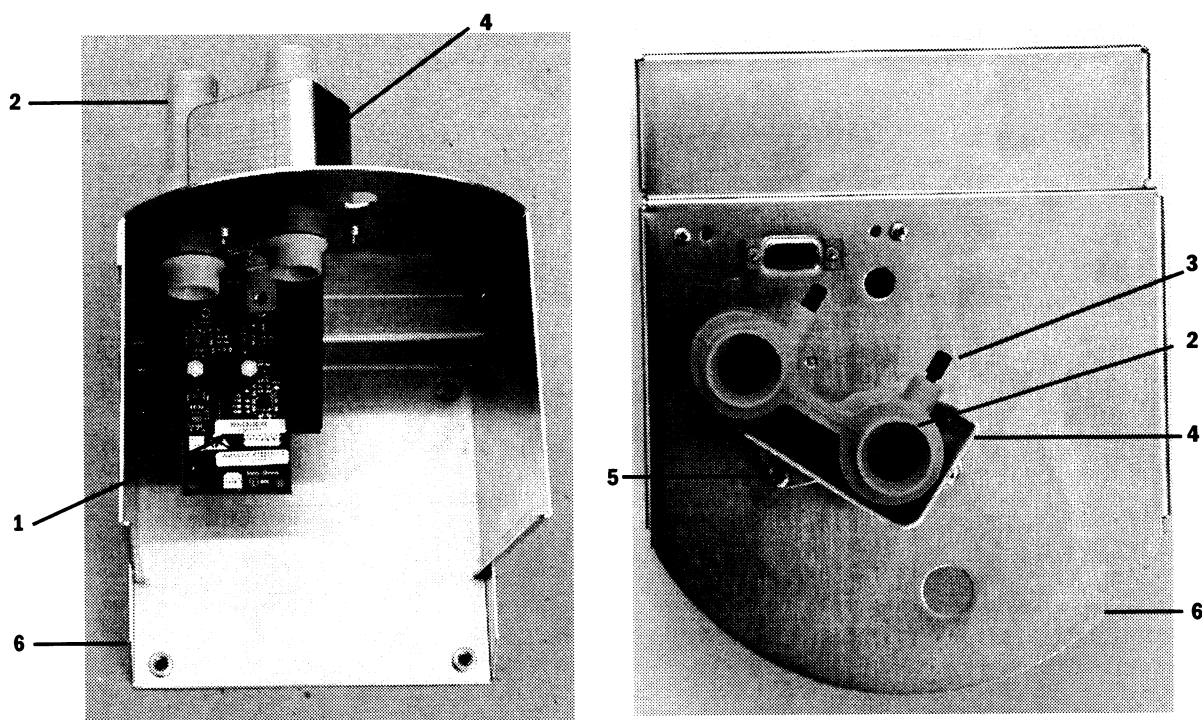

Figure 8-11 ▪ Mounting Bracket, pneumatic engine (Aestiva machine)

Item	Description	Stock Number
1	Pneumatic Engine Board, PEB	1504-8508-000
2	Cuff, exhalation valve interface	1503-3589-000
3	Plug, 1/8-inch	1006-3611-000
4	Shield, cuff protection	1503-3214-000
5	Screw, M4x8 Pozidriv PAN	1006-3178-000
6	Bracket, pneumatic engine housing	1503-3206-000

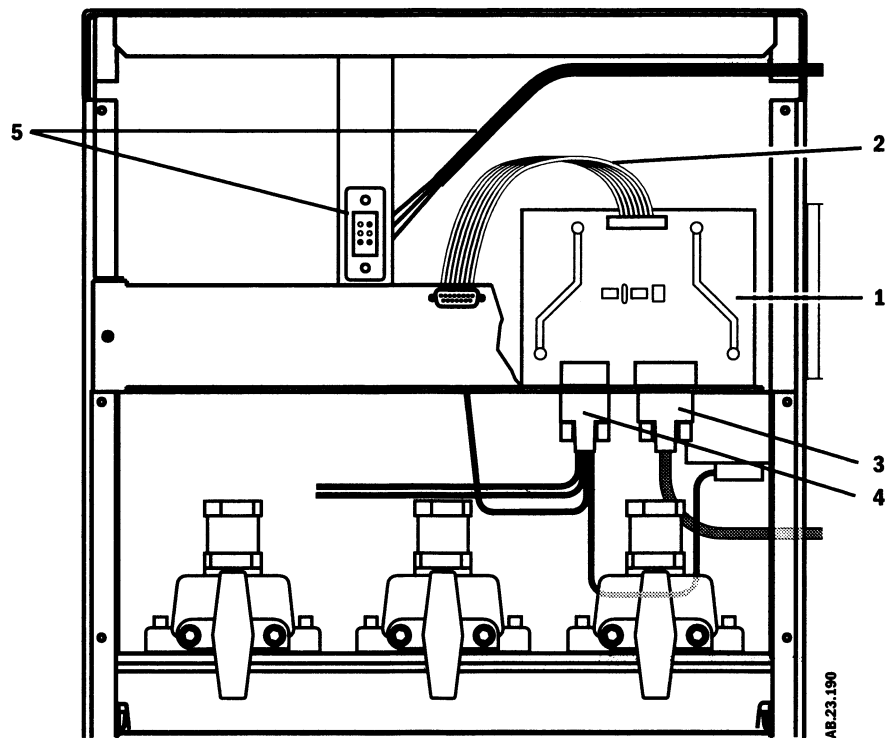

Figure 8-12 ▪ Serial Adapter Board (Aestiva machine)

Note: For the Serial Isolation and Connector Board in the Aespire machine, refer to the Technical Reference manual for the Aespire machine.

Item	Description	Stock Number
1	Serial Adapter Board, SAB	1504-5503-000
2	Cable, ribbon, serial out	1006-3703-000
3	Cable, to control board	1504-5606-000
4	Cable, machine switches	1006-3707-000
5	Power Cord Harness, with connector	1504-5705-000

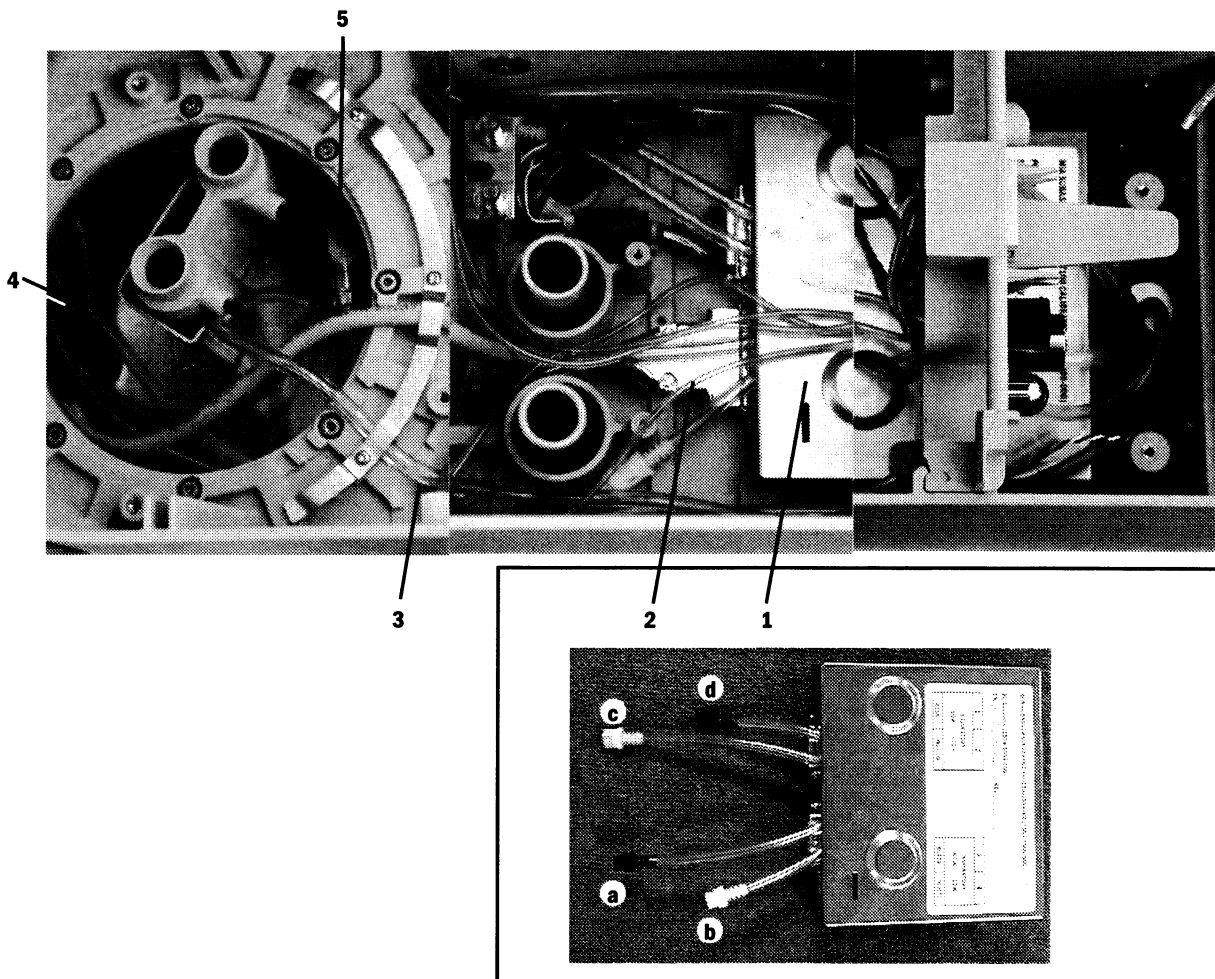

Figure 8-13 ▪ Subfloor components (Aestiva machine)

Note: For the Ventilator Monitoring Board (VMB) in the Aespire machine, refer to the Technical Reference manual for the Aespire machine.

Item	Description	Stock Number
1	Monitoring Interface Assembly, MIA	1504-7000-000
	a - Coupling, inline, black	1503-3128-000
	b - Coupling, inline, white	1503-3119-000
	c - Coupling, inline, yellow	1503-3132-000
	d - Coupling, inline, blue	1503-3130-000
2	Cable, MIA to control board	1504-5604-000
3	Tubing, 1/4-inch, pressure gauge port to PEB	0994-6370-010
4	Hose Assembly, drive gas supply	1503-3219-000
5	Cable, pneumatic engine	1504-5605-000

Notes

In this section

Schematics are subject to change without notice.

Circuit boards are available only as complete assemblies.

Figure 9-1 •	Aestiva 7100 ventilator block diagram	9-2
Figure 9-2 •	Aespire 7100 ventilator block diagram	9-3
Figure 9-3 •	Aestiva 7100 anesthesia machine pneumatic diagram	9-4
Figure 9-4 •	Aespire 7100 anesthesia machine pneumatic diagram	9-5
Figure 9-5 •	Aestiva 7100 ventilator wiring diagram	9-6
Figure 9-6 •	Aestiva 7100 Pneumatic Engine and Pneumatic Engine Board	9-7
Figure 9-7 •	Aestiva 7100 breathing system switches to Monitoring Interface Assembly . .	9-7
Figure 9-8 •	Aespire 7100 ventilator wiring diagram	9-8
Figure 9-9 •	Aespire 7100 ventilator tubing diagram	9-9
Figure 9-10 •	Control Module block diagram	9-10
Figure 9-11 •	Display Panel block diagram	9-11

9 Schematics and Diagrams

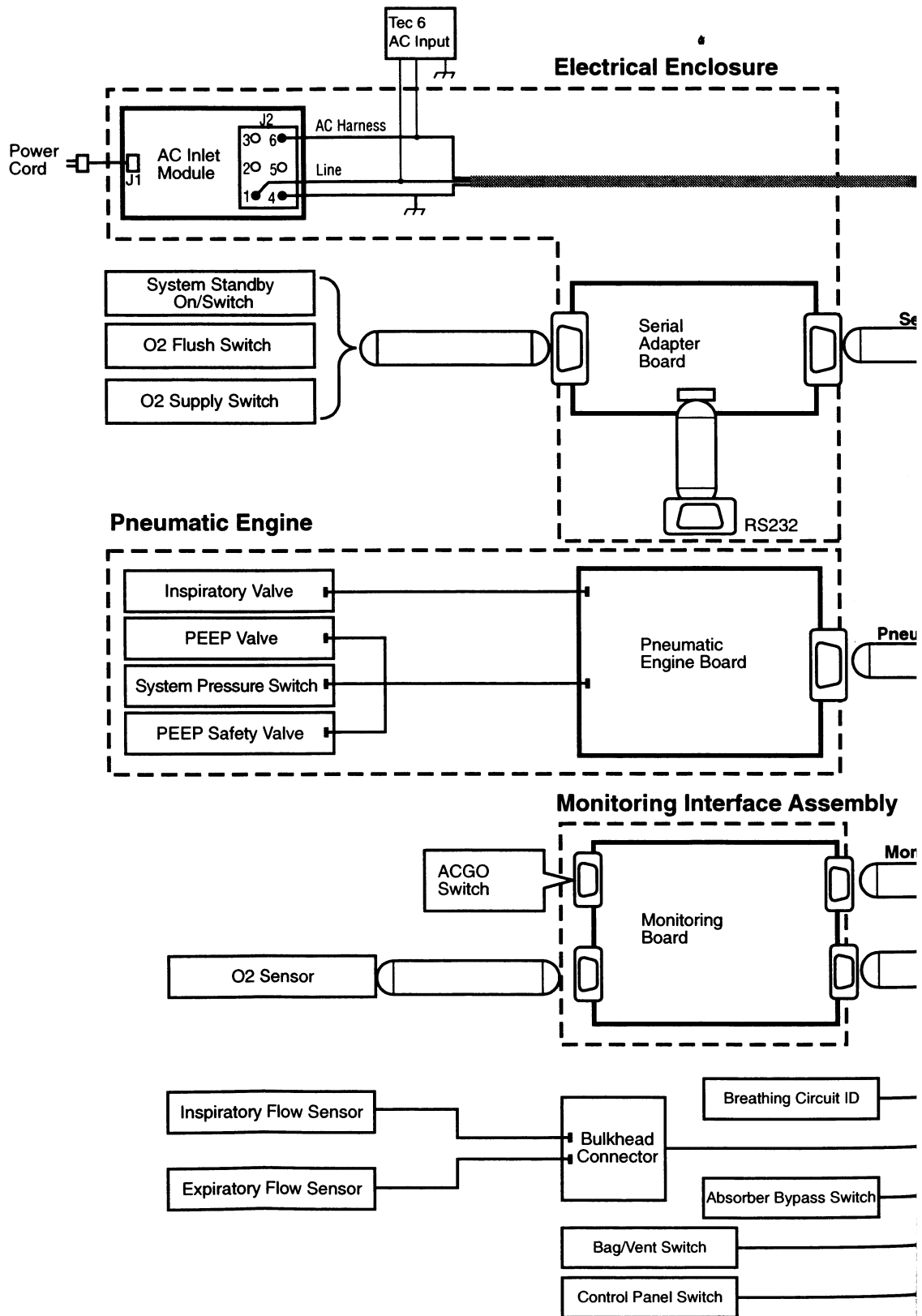

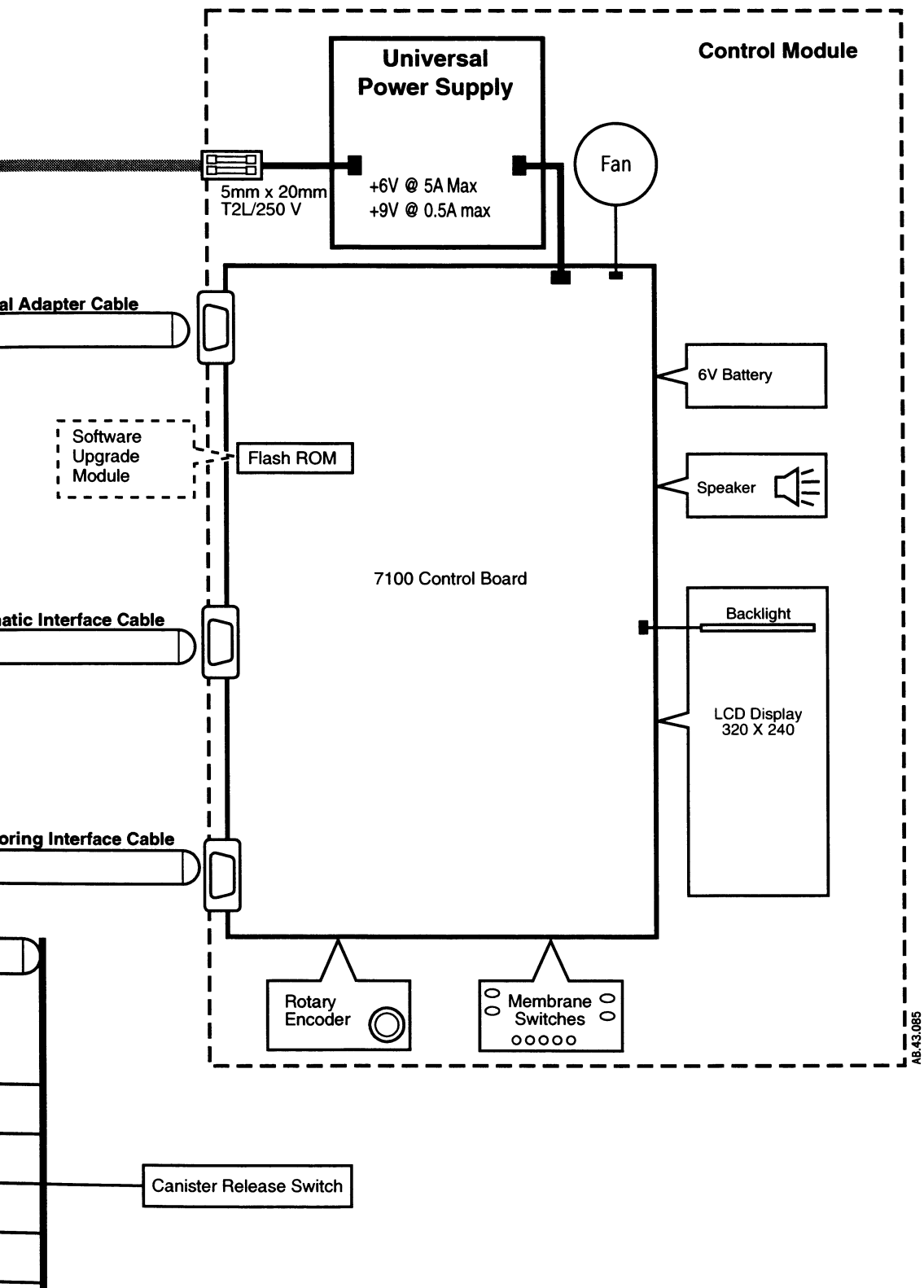

Figure 9-1 • Aestiva 7100 ventilator block diagram

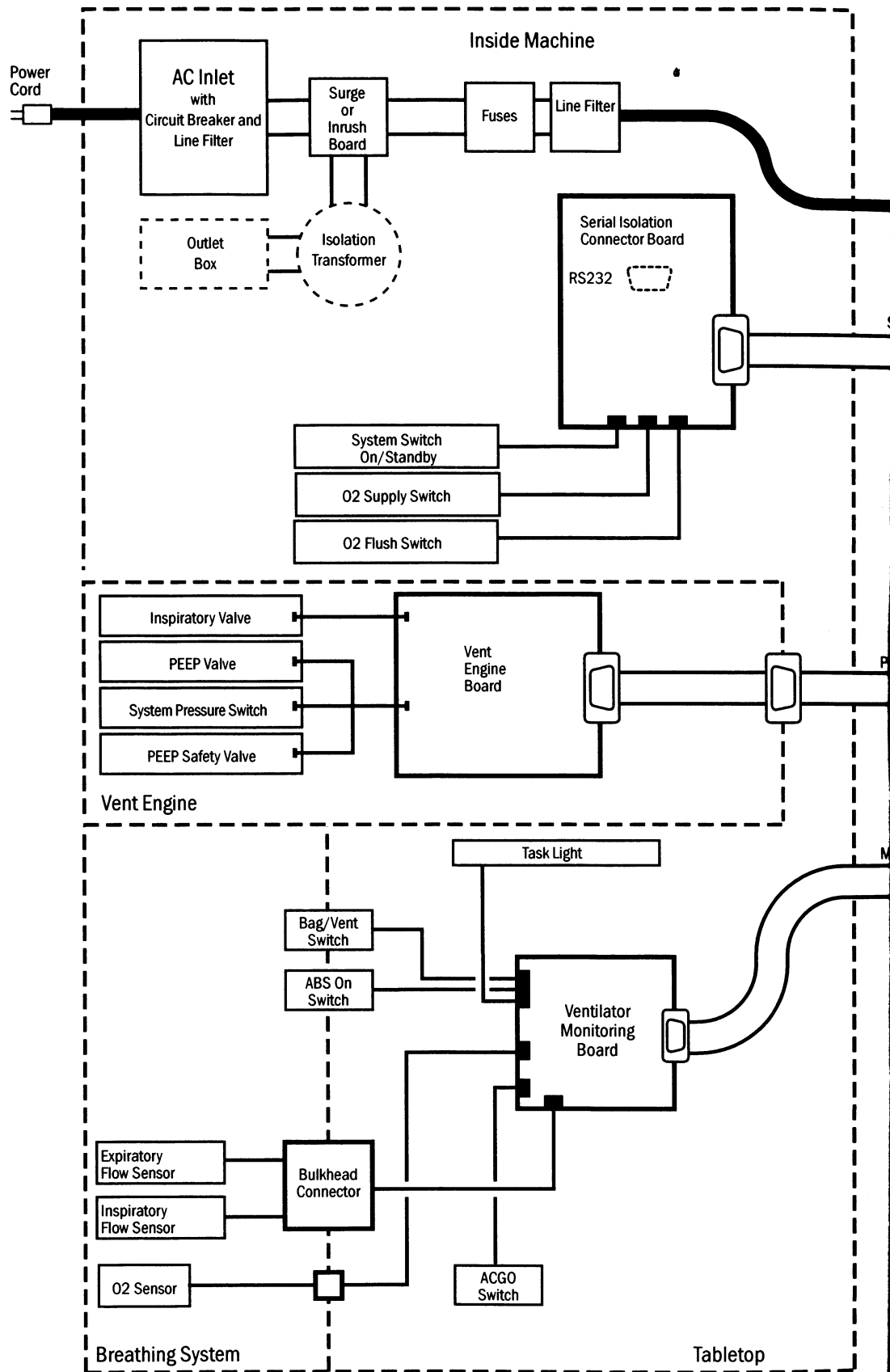
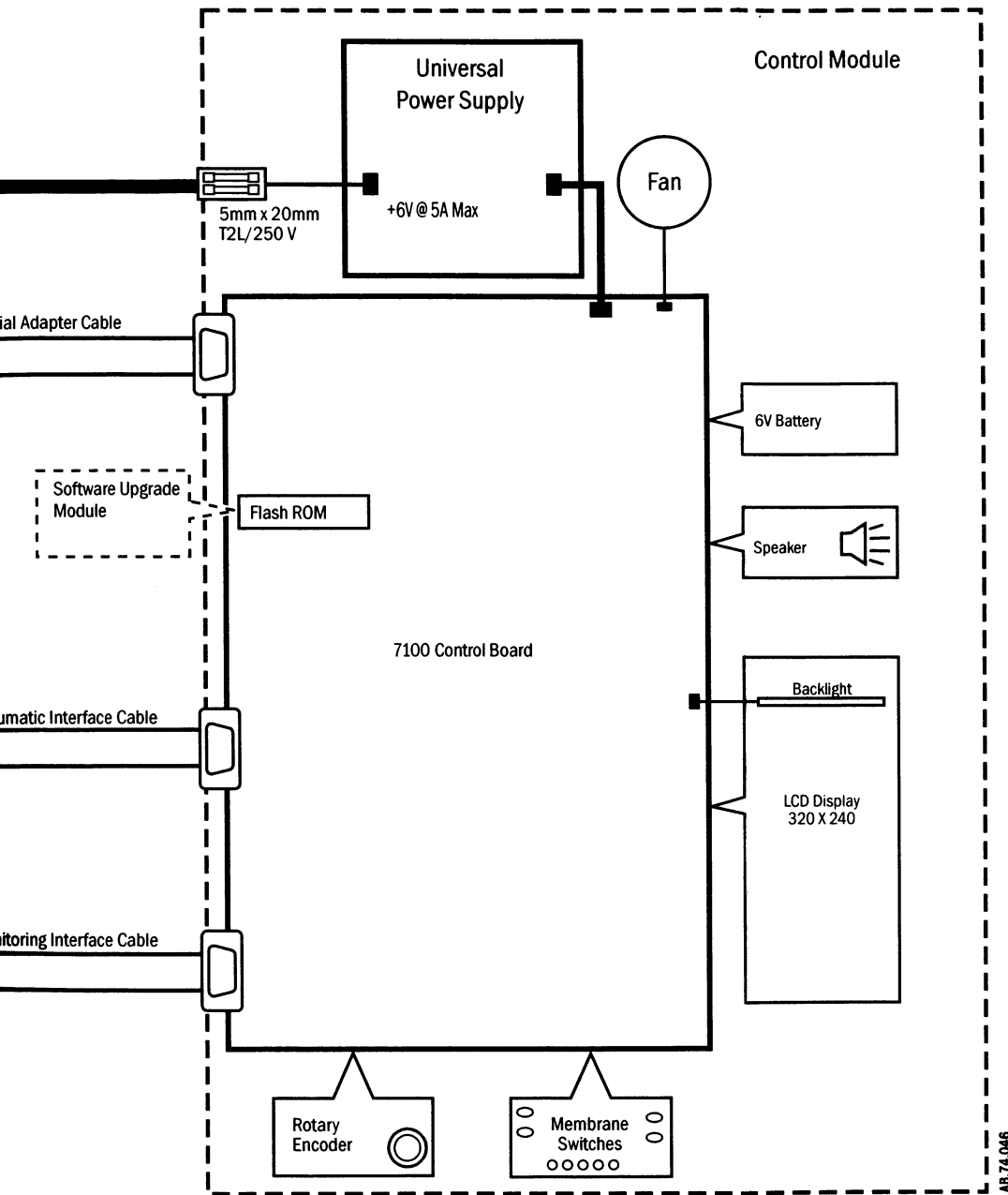

Figure 9-2 • Aespire 7100 ventilator block diagram



7100 Anesthesia Ventilator

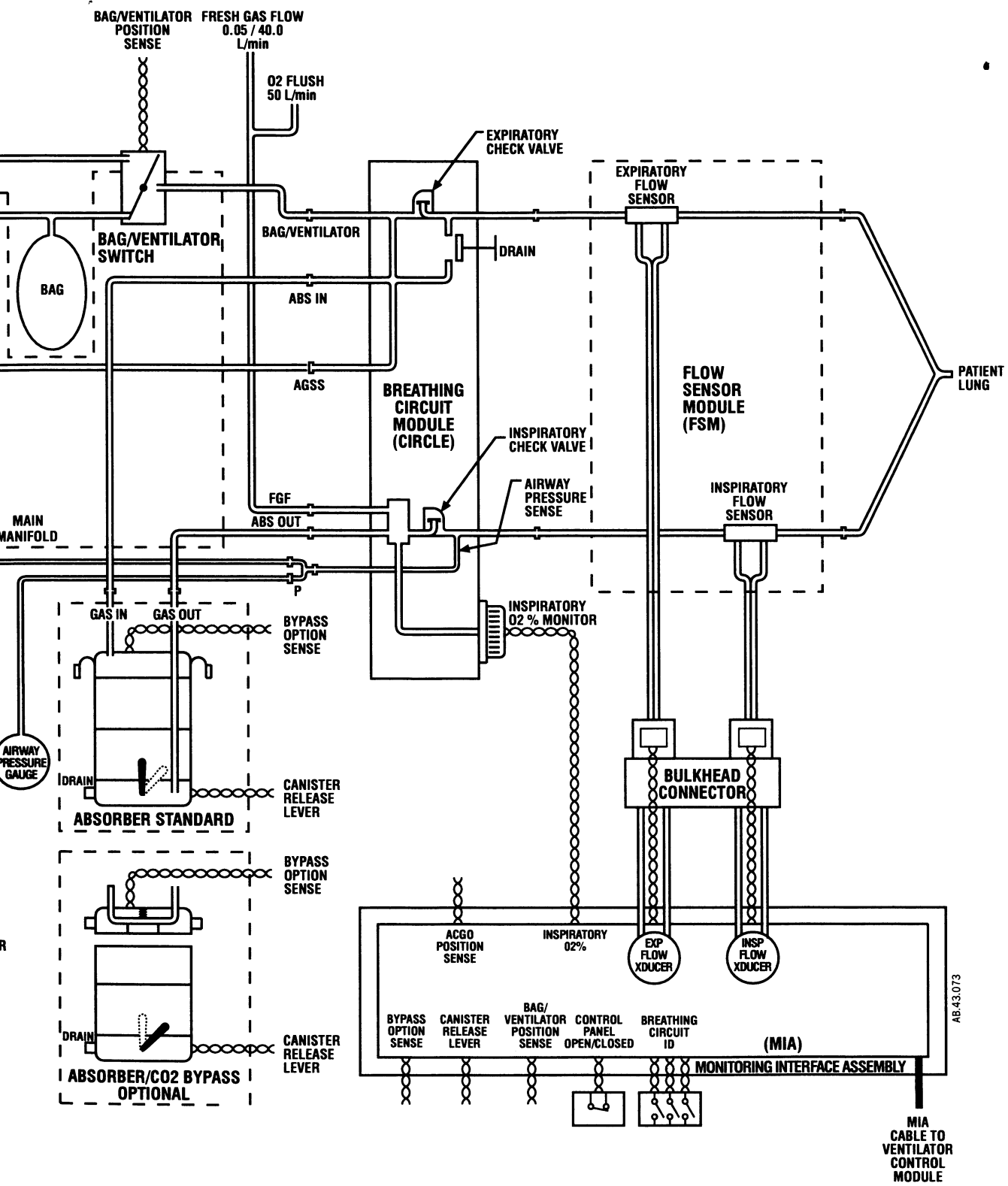

Figure 9-3 • Aestiva 7100 anesthesia machine pneumatic diagram

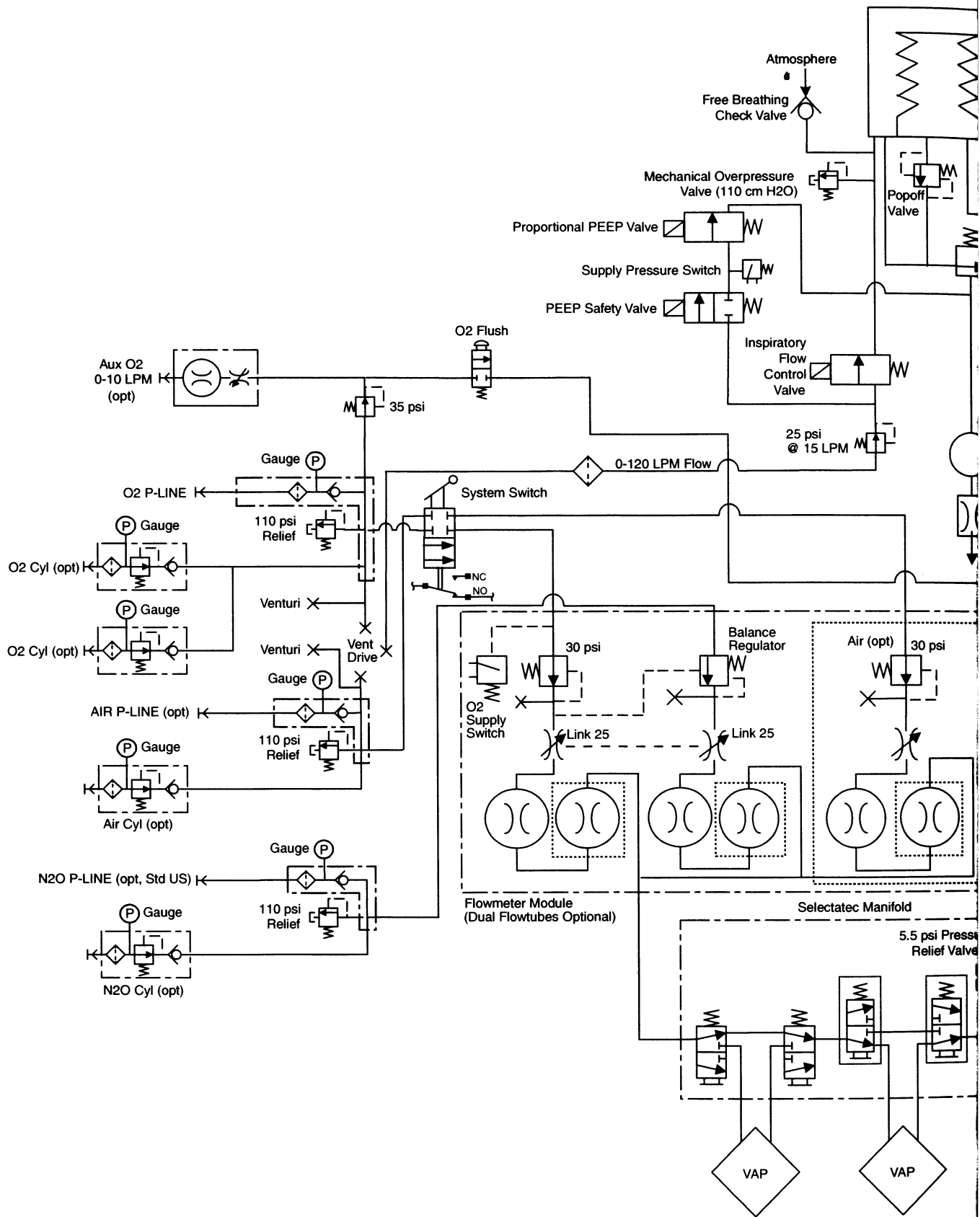
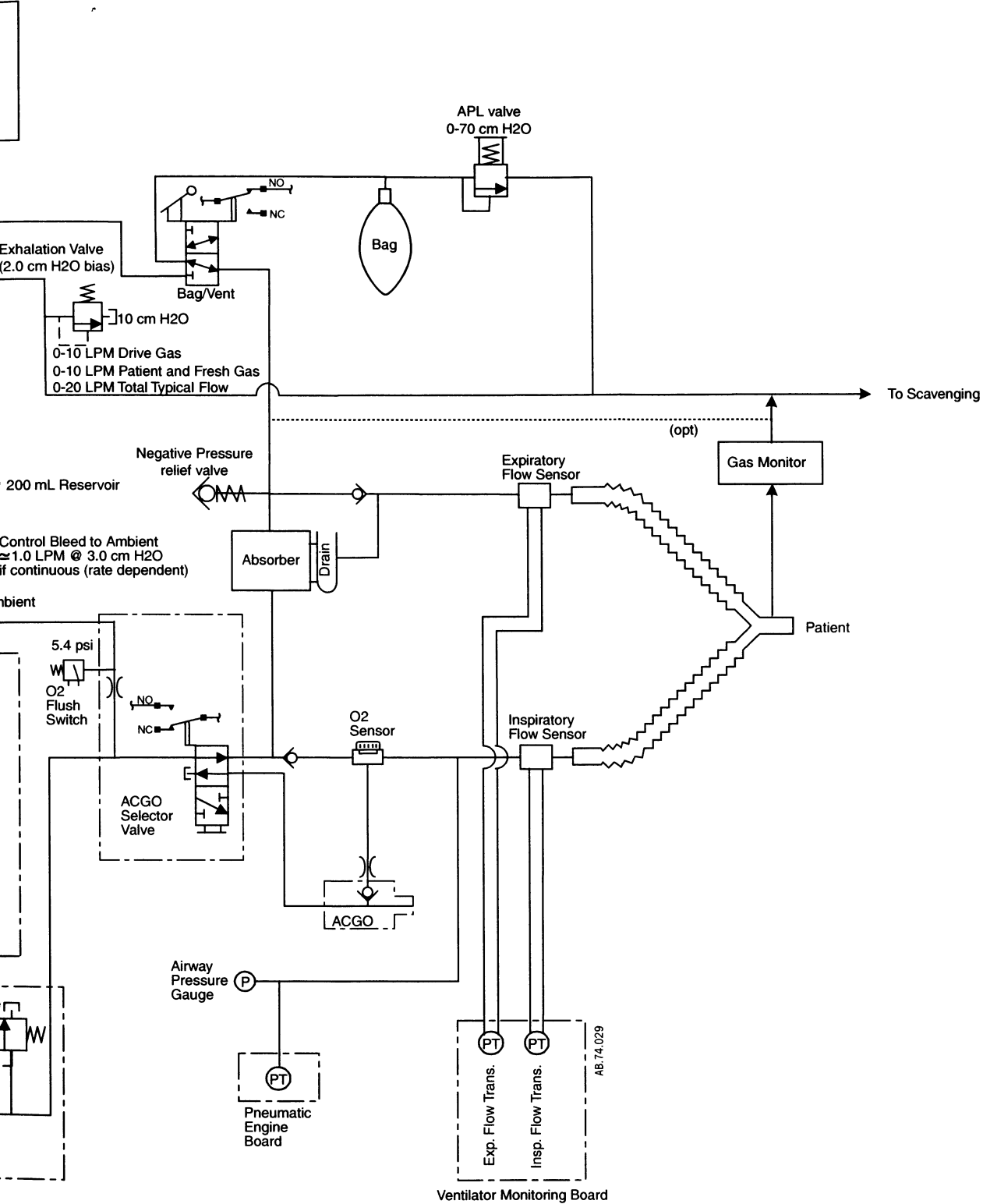
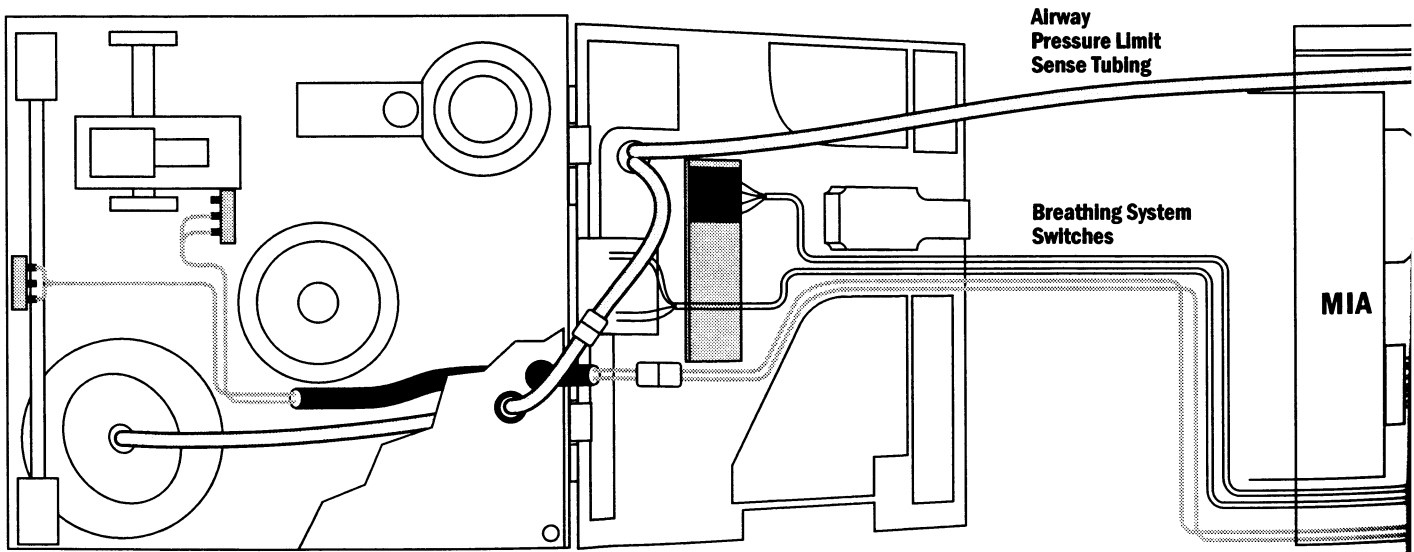
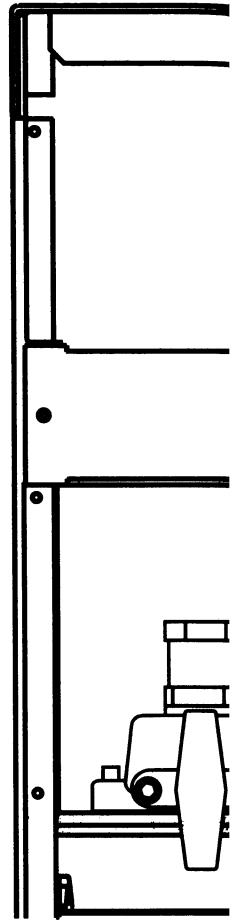
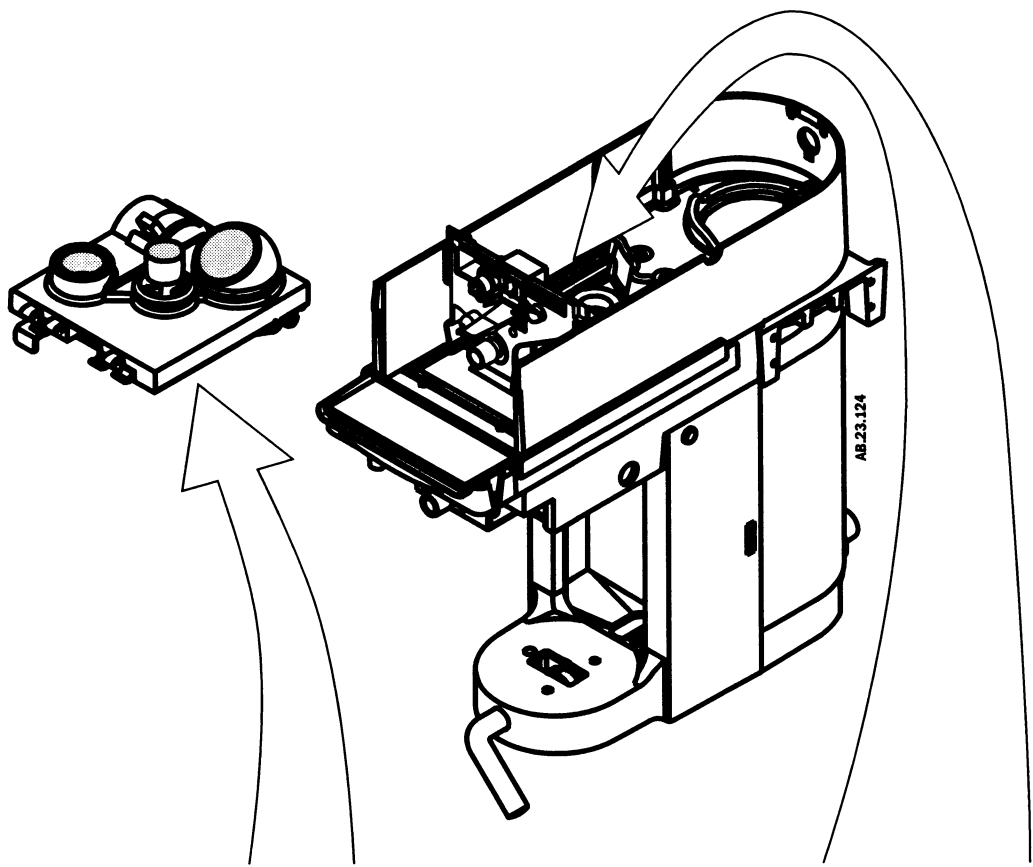

Figure 9-4 • Aespire 7100 anesthesia machine pneumatic diagram





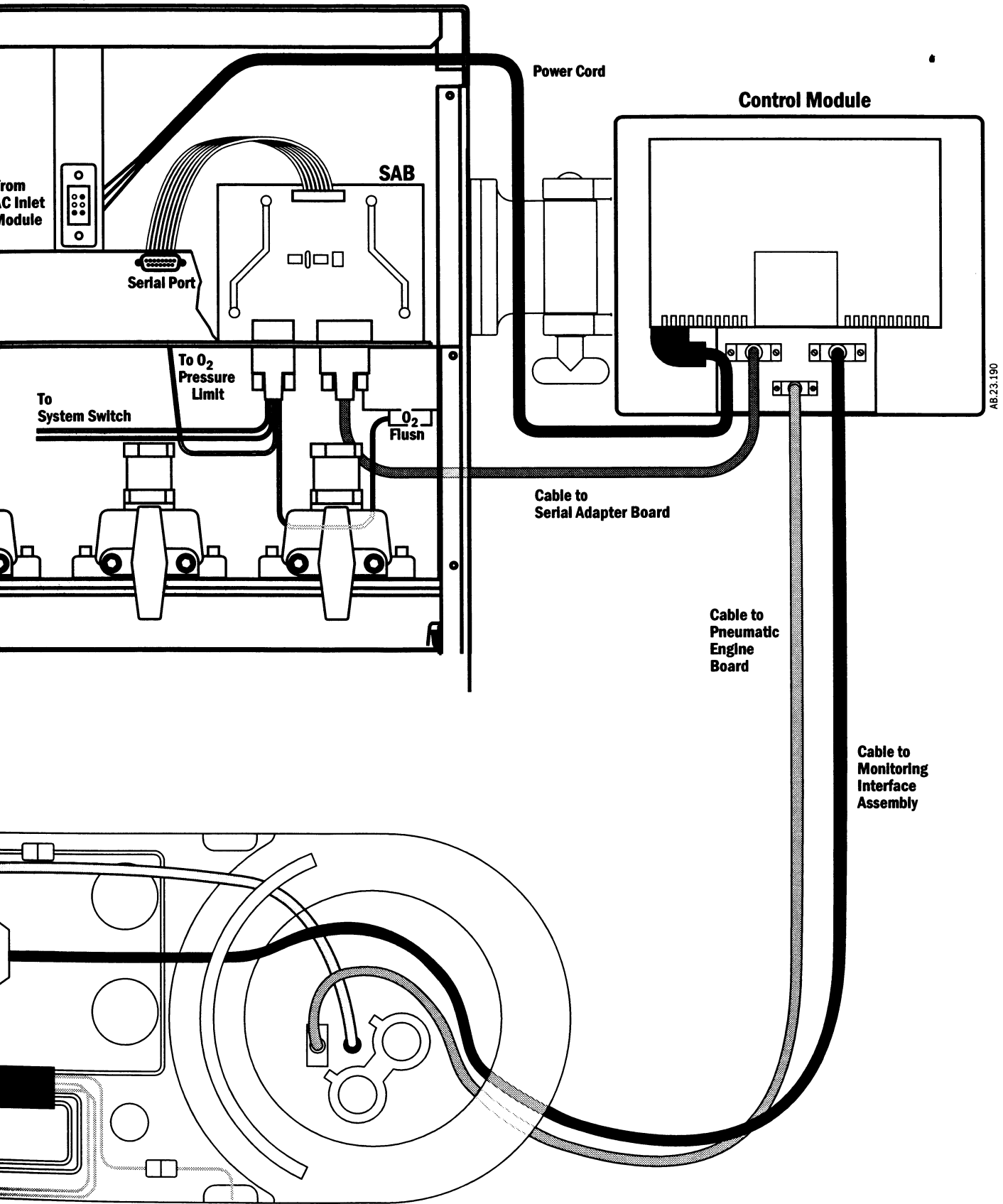

Figure 9-5 • Aestiva 7100 ventilator wiring diagram

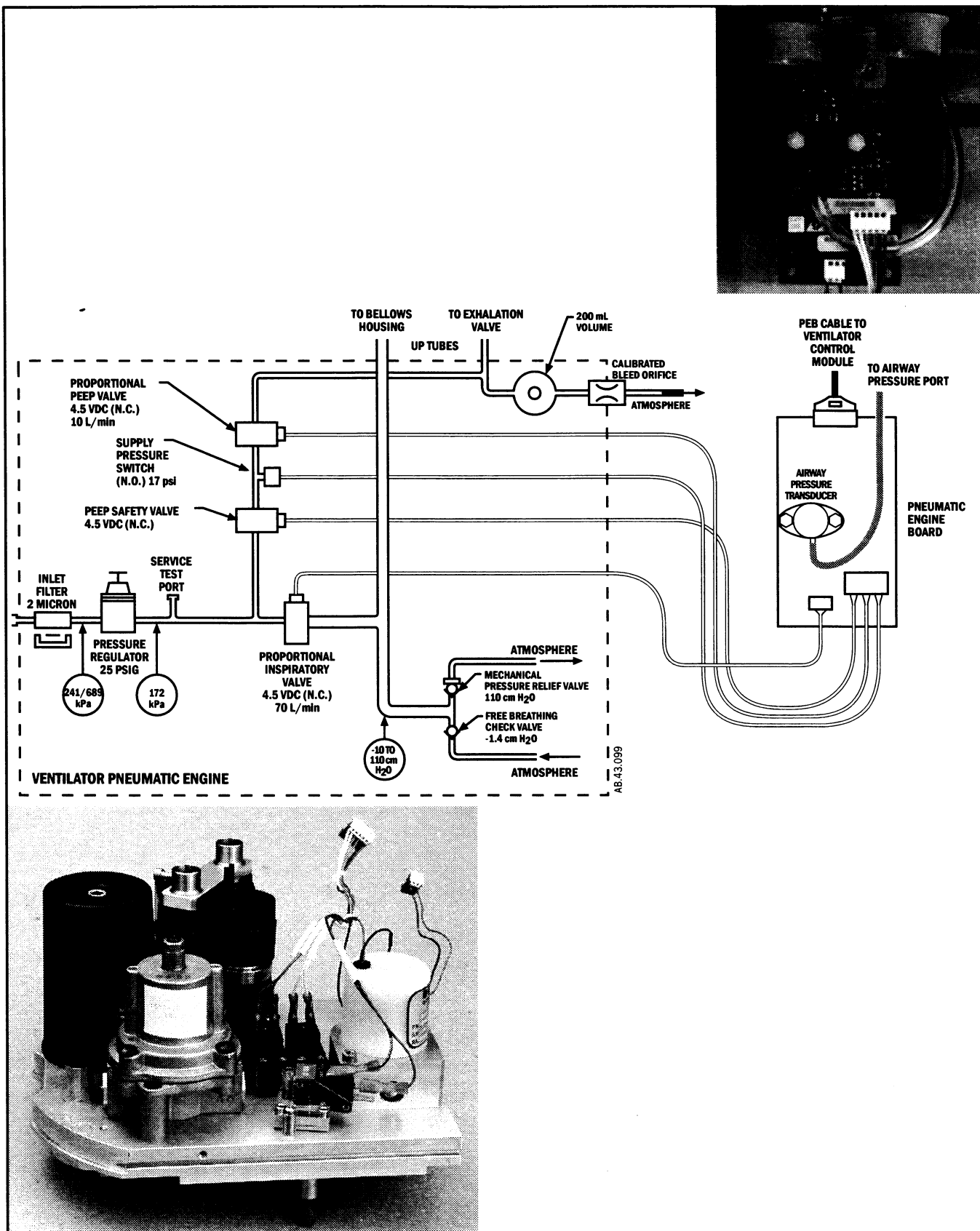

Figure 9-6 • Aestiva 7100 Pneumatic Engine and Pneumatic Engine Board

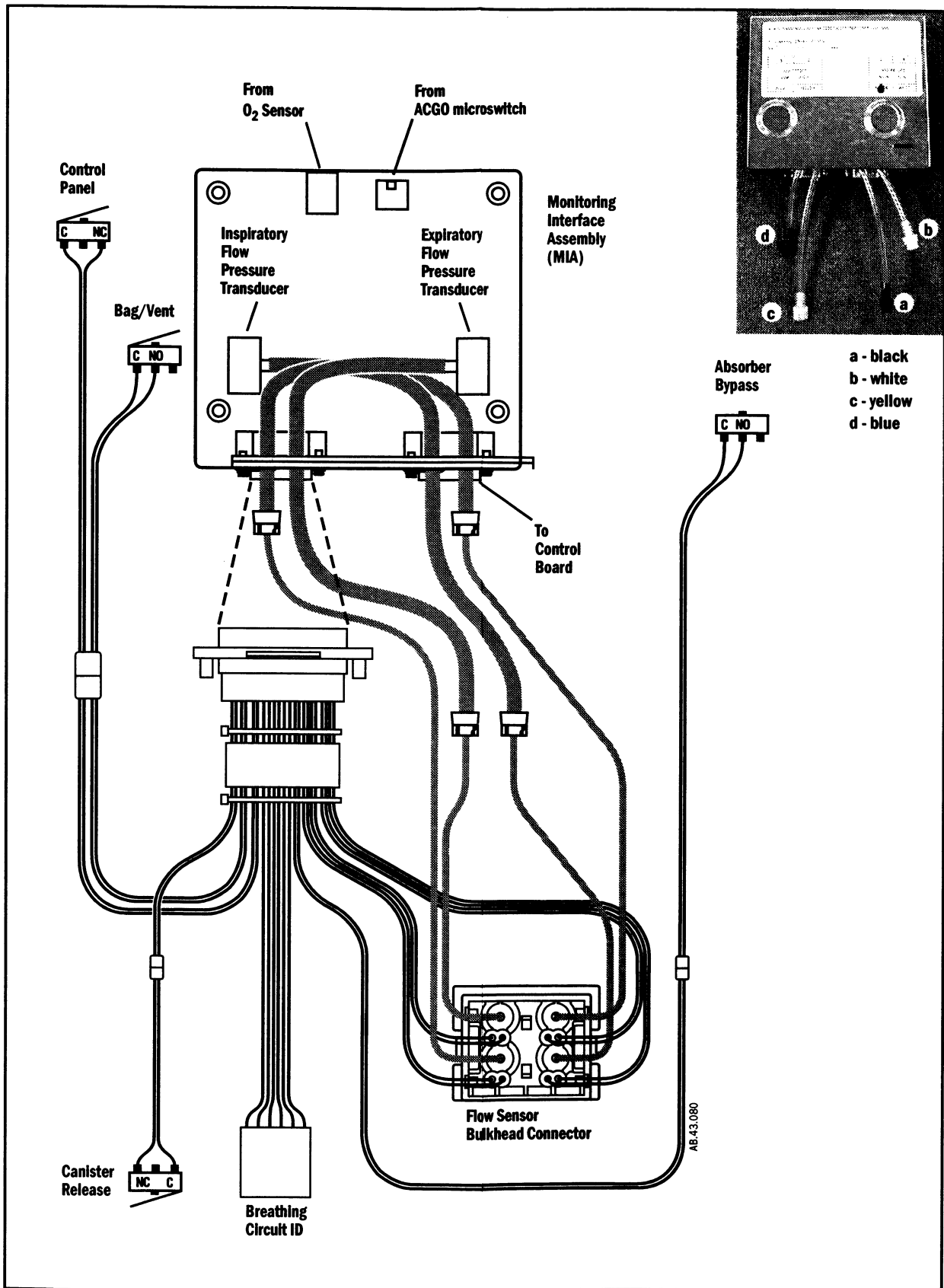
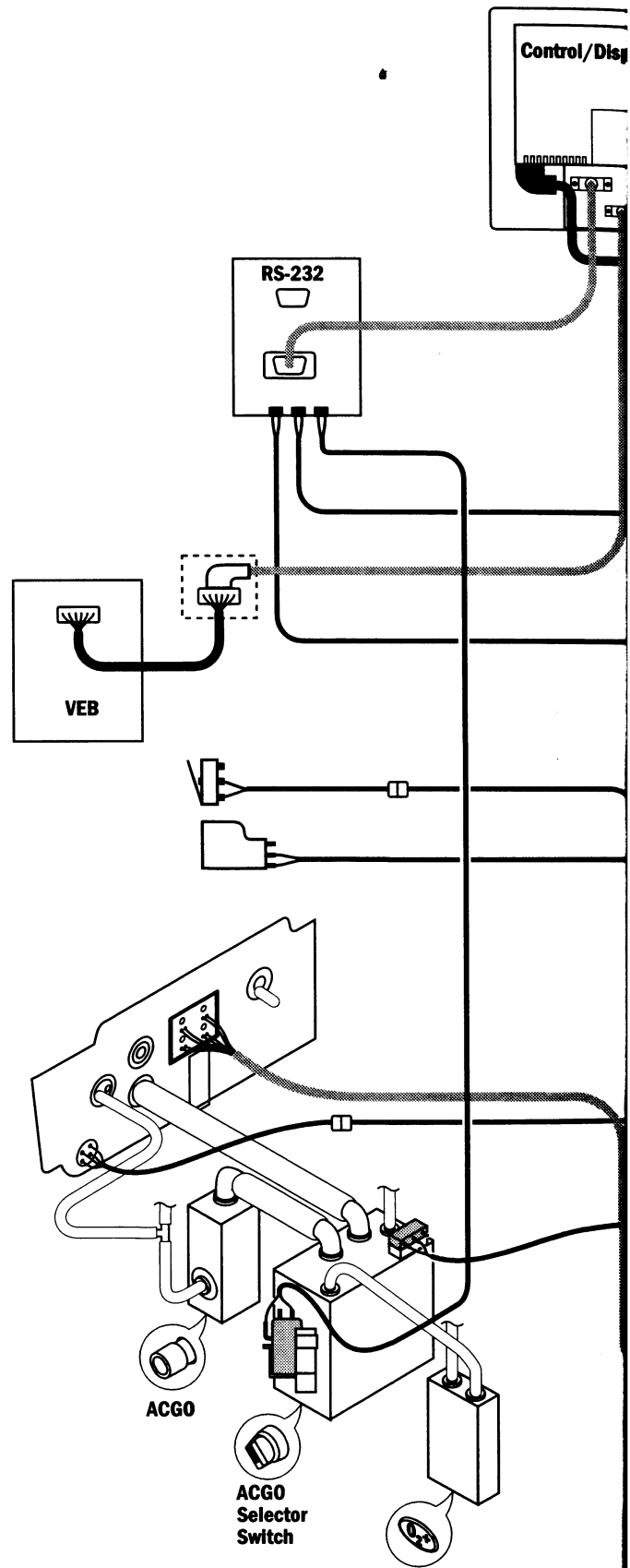

Figure 9-7 • Aestiva 7100 breathing system switches to Monitoring Interface Assembly



Key to Symbols

VEB = Vent Engine Board

VMB = Ventilator Monitoring Board

ACGO = Auxiliary Common Gas Outlet

7100 Anesthesia Ventilator

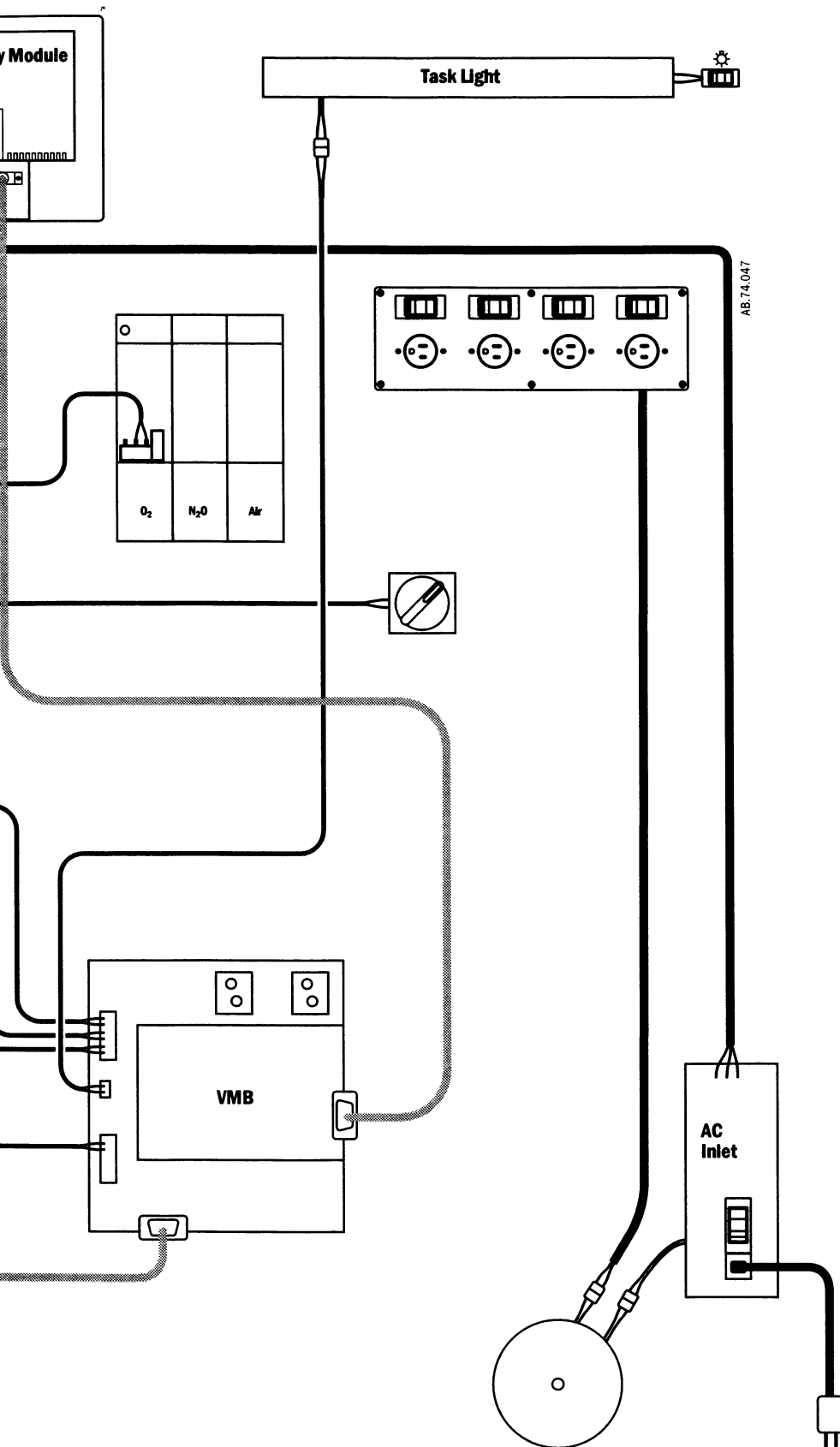
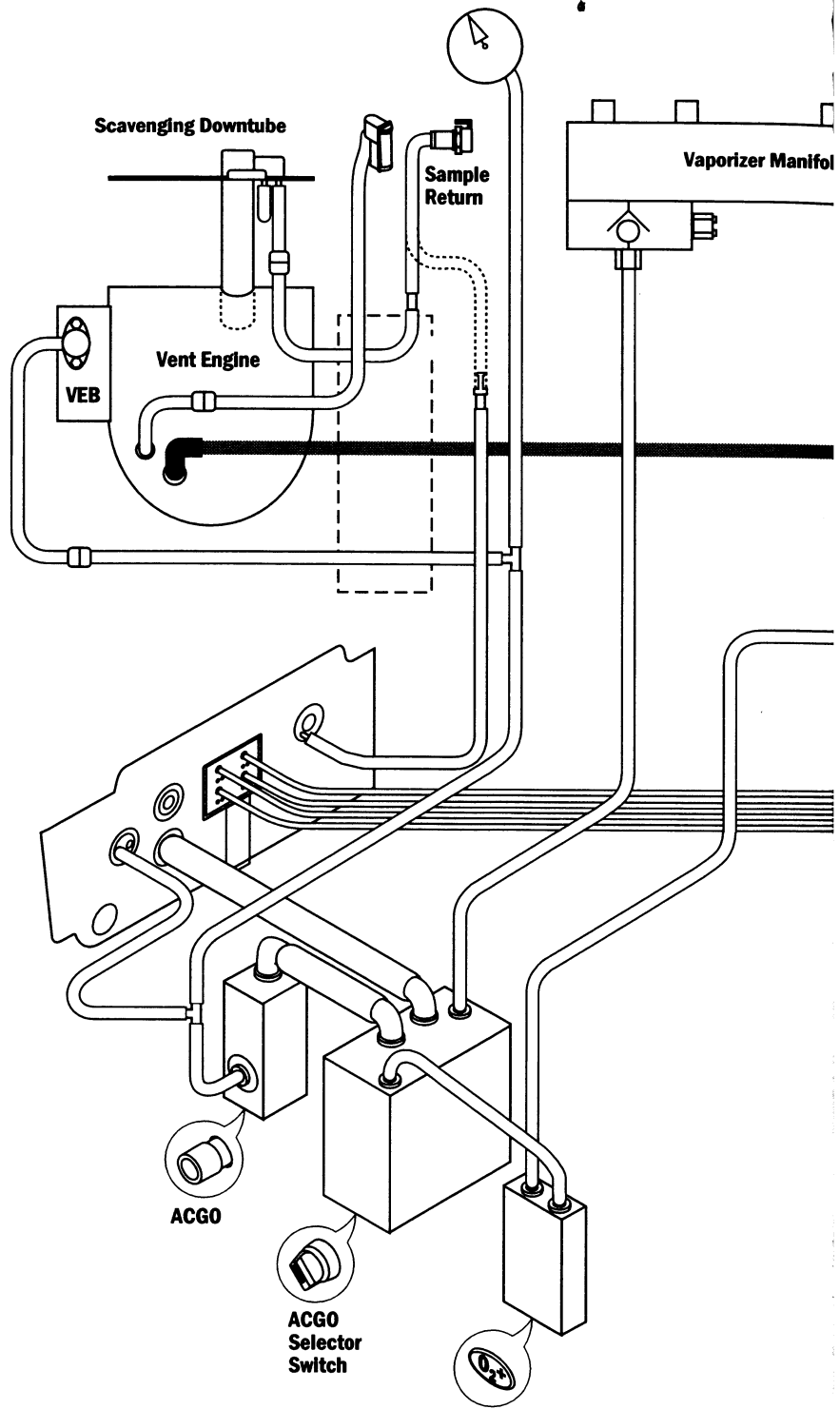

Figure 9-8 • Aespire 7100 ventilator wiring diagram



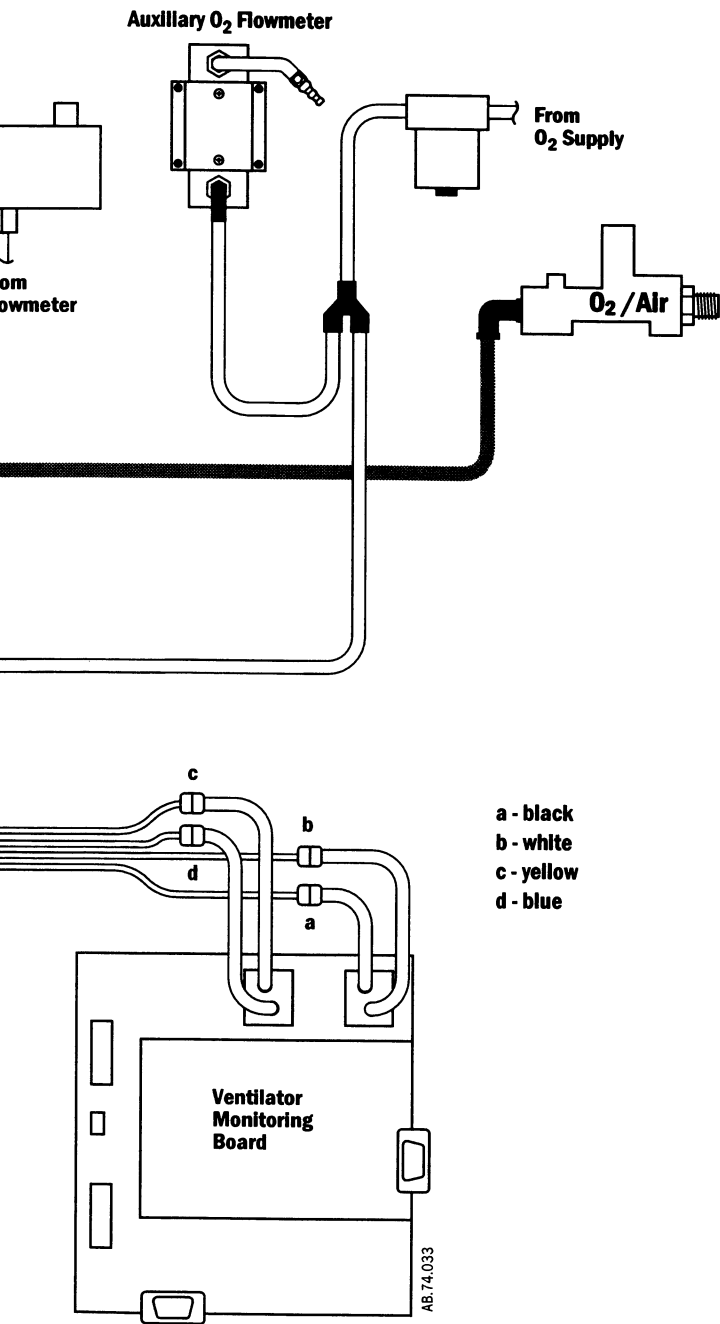
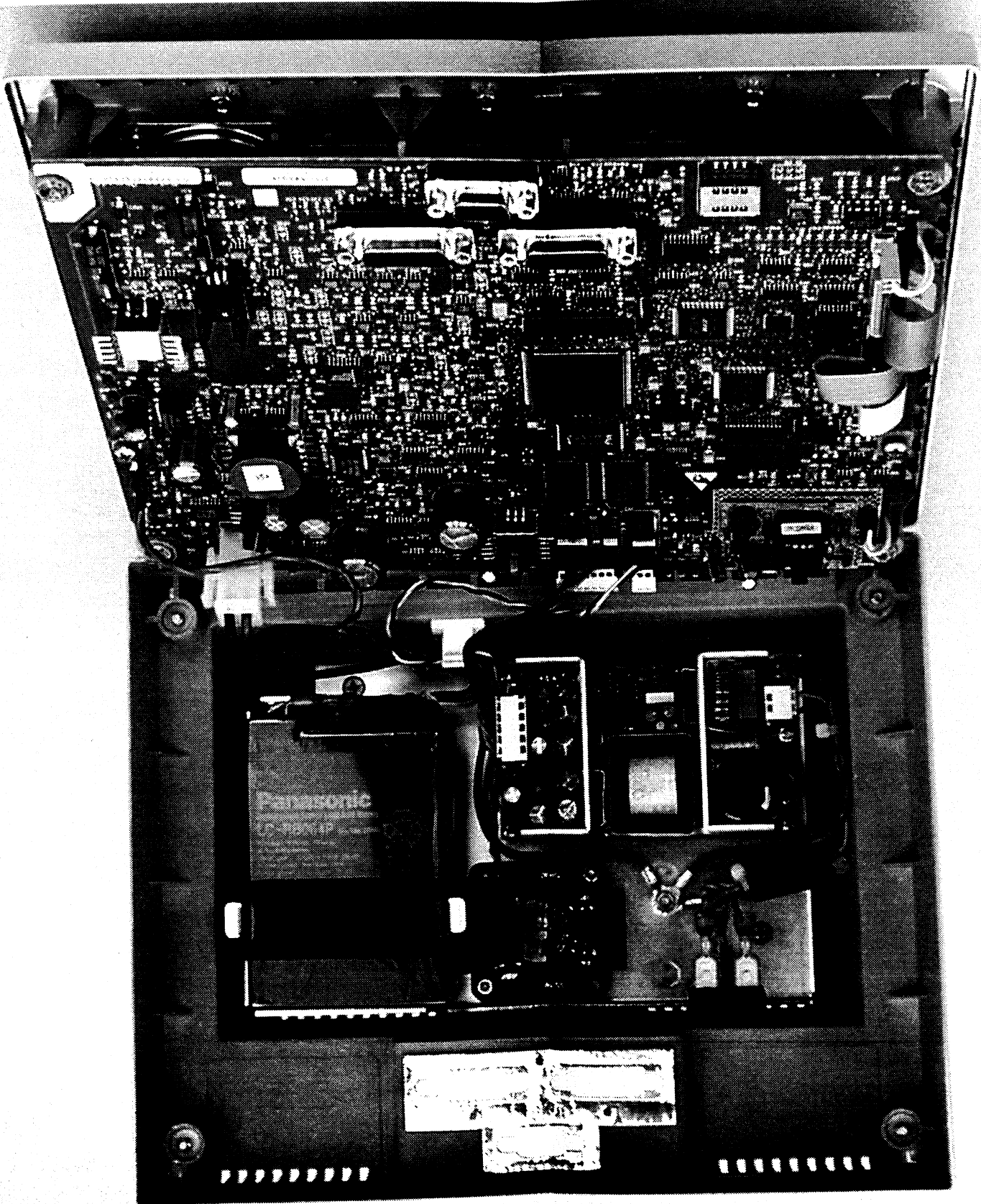
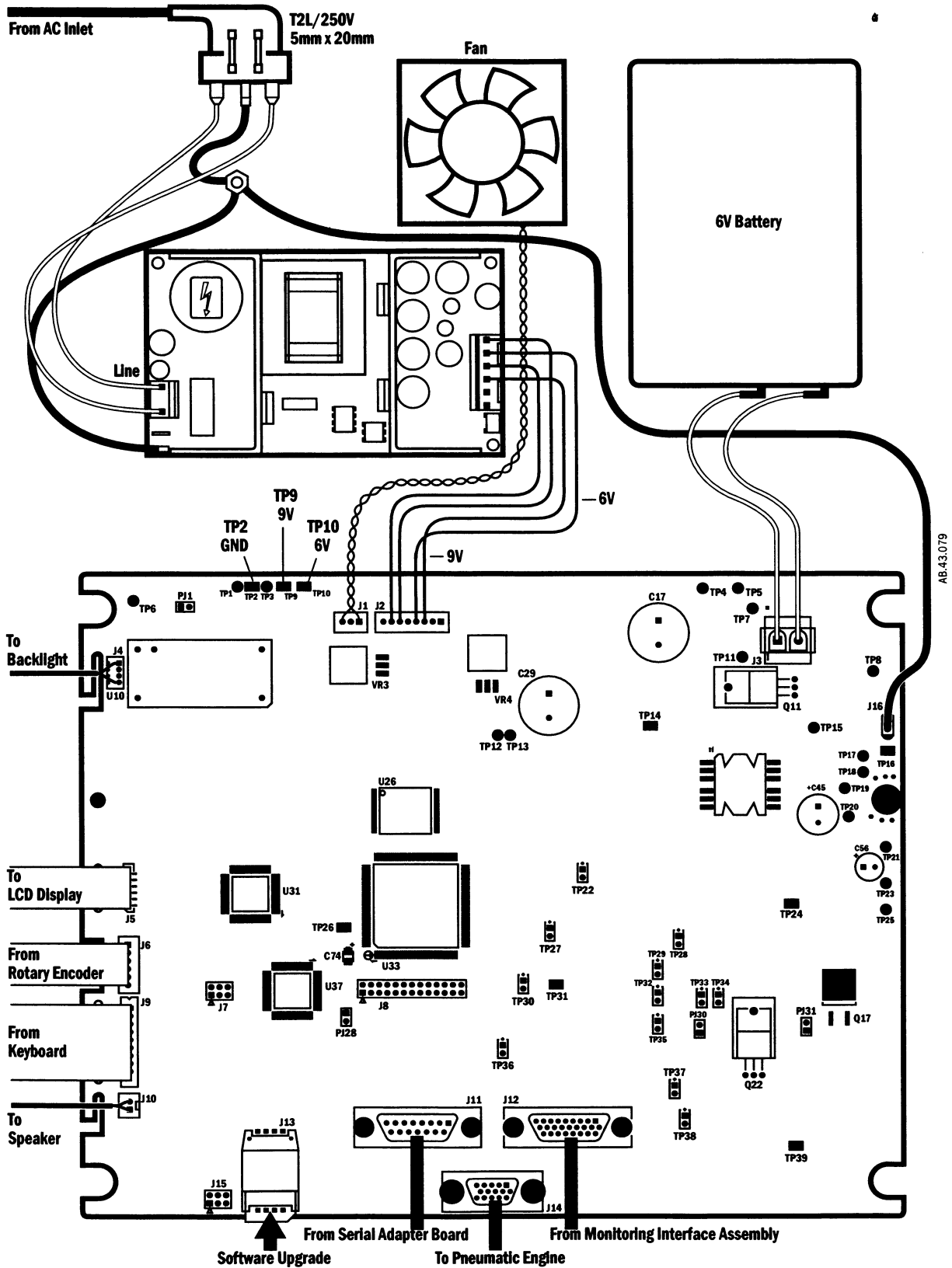

Figure 9-9 • Aespire 7100 ventilator tubing diagram

Figure 9-10 • Control Module block diagram





AB.43.079

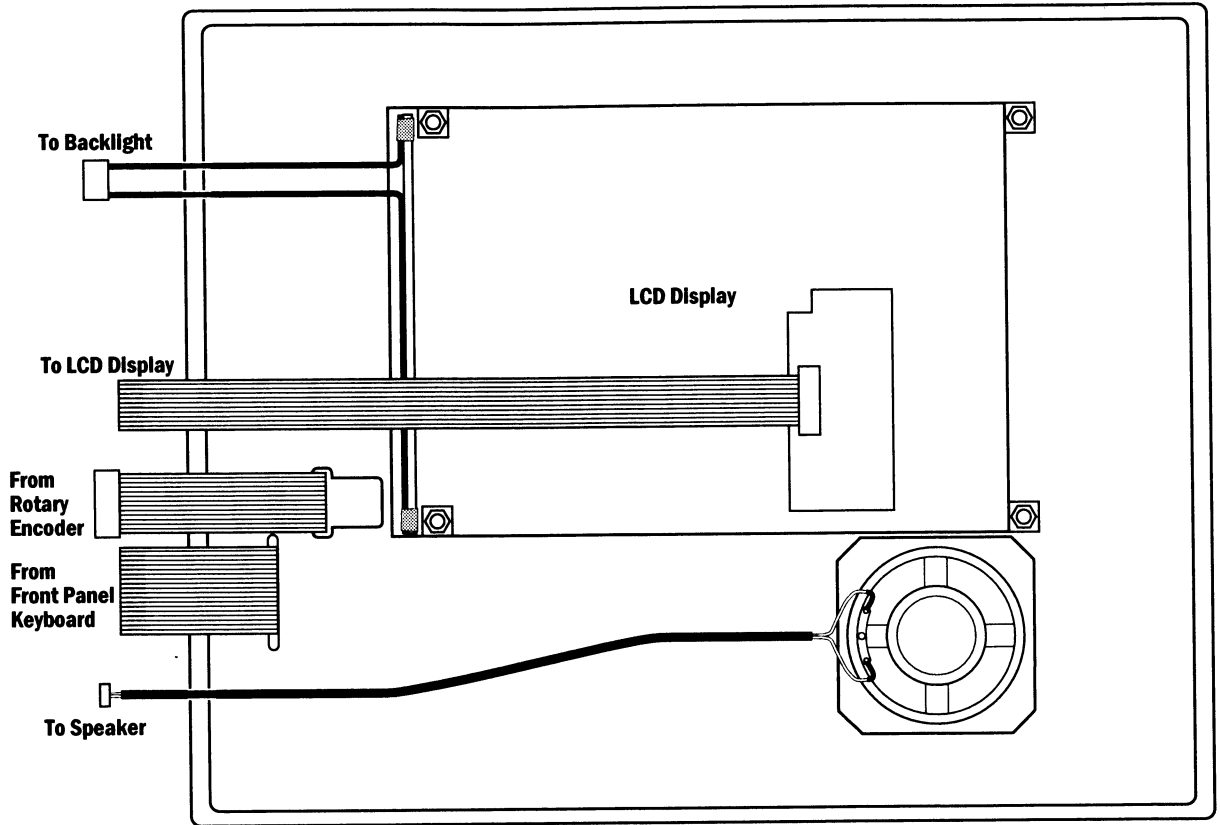

AB.43.098

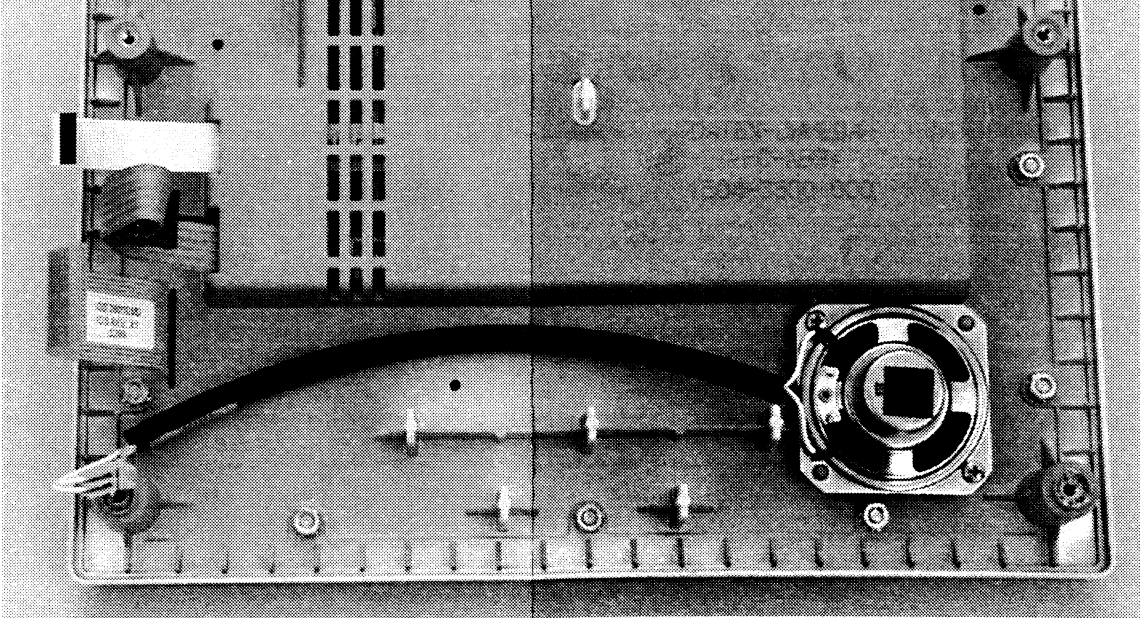
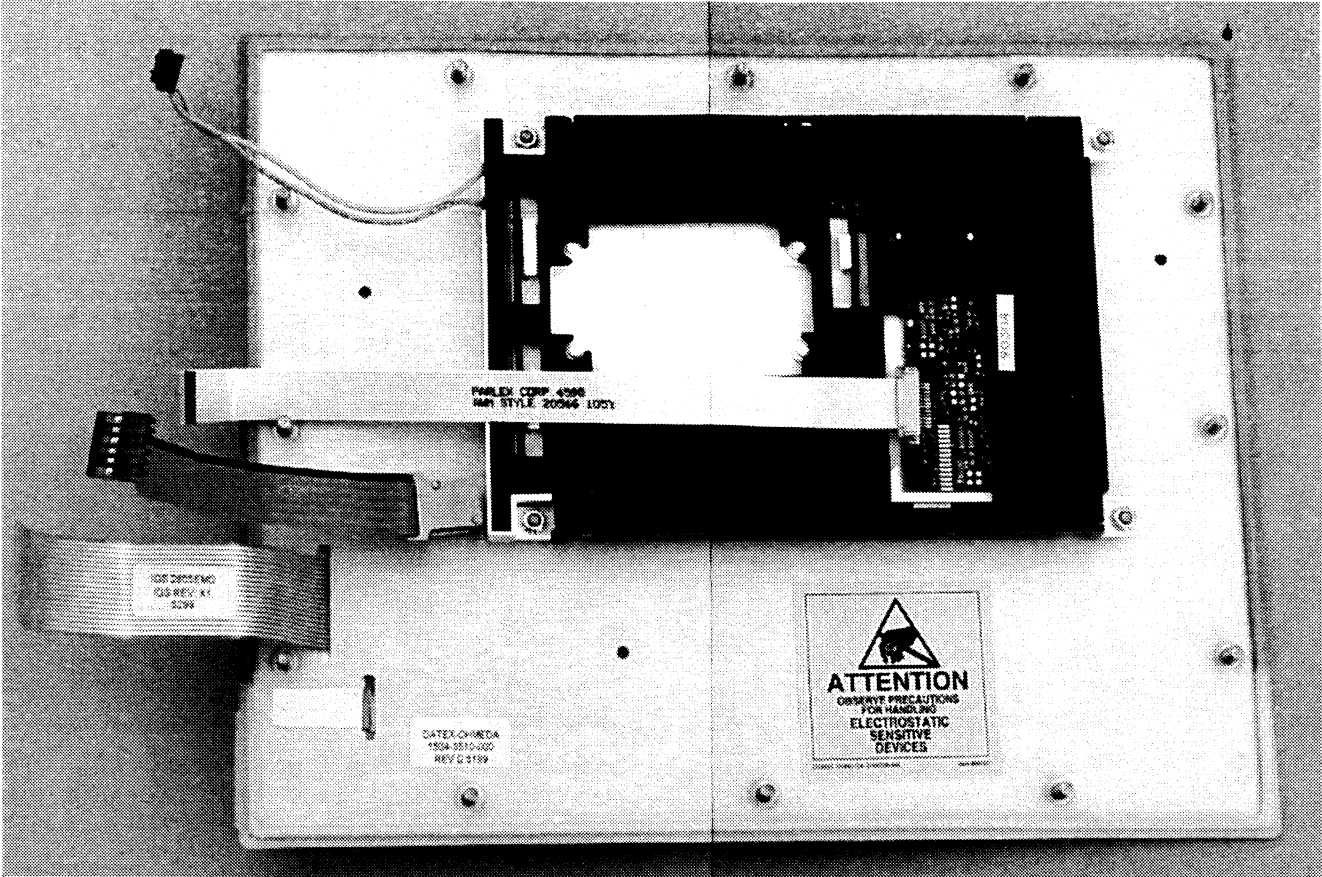
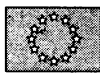

Figure 9-11 • Display Panel block diagram

Corporate Office



EC REP

GE Healthcare Finland Oy
Kuortaneenkatu 2
Helsinki, Finland
FI-00510
Tel 358 10 394 11
Fax 358 9 146 3310

North America

United States

**Customer Service,
Technical Support and
Distribution Center**
Datex-Ohmeda, Inc.
3030 Ohmeda Drive
Madison, WI 53718-6794
USA
Tel 1 800 345 2700
Fax 1 608 221 4384

Equipment Service Center

GE Healthcare
1701 Military Trail,
Suite 150
Jupiter FL 33458-7887
USA
Tel 1 561 575 5000
Fax 1 561 575 5070

Canada

GE Healthcare
2300 Meadowdale Blvd
Mississauga, Ontario
L5N 5P9
Canada
Tel 1 800 668 0732
Fax 1 905 858 5292

Asia/Pacific

China

GE (China) Co. Ltd -
Healthcare
2401 MAXDO Center
No. 8 Ying Yi Road
Hongqiao
Development Zone
200336 Shanghai
China
Tel 86-21-52574650
Fax 86-21-52082012

GE Medical Systems (China)
Co., Ltd.
No. 19 Changjiang Road,
Wuxi
National Hi-Tech
Development Zone,
Jiangsu, PR China 214028
Tel 0510-85225888
Fax 0510-85226688

Hong Kong

GE Healthcare
Hong Kong Ltd.
11/F, The Lee Gardens,
33 Hysan Avenue
Causeway Bay
Hong Kong
Tel +852 2100 6300
Fax +852 2100 6292

India

WIPRO GE Medical
Systems Pvt. Ltd.
4 Kadugodi Industrial Area
Sadaramangala
Bangalore
Karnataka 560067
India
Tel +914 1801 0000
Fax +91 28 452 926

Indonesia

PT GE Technology
Indonesia
BRI Building Tower II
26th Floor
Jln. Jend Sudirman Kav.
44-46 Jakarta 10210,
Indonesia
Tel +6221 573 0545
Fax +6221 574 7117

Japan

GE Yokogawa
Medical Systems
4-7-127 Asahigaoka,
Hino-shi,
Tokyo 191-8503
Japan
Tel 81 42 585 5111
Fax 81 42 585 5360

Korea

GE Medical Systems Korea
Seowoo B/D 837-12
Yeoksamdong
Kangnamgu
Seoul, OS 135-080
Korea
Tel +82 2301 66001
Fax +82 2567 7357

Malaysia

General Electric
International Inc.
Suite 3B-8-3, Block 3B
Level 8, Plaza Sentral
Jalan Stesen Sentral 5
Kuala Lumpur Sentral
50470 Kuala Lumpur
Malaysia
Tel +603 2273 9788
Fax +603 2273 3486

Philippines

GE Philippines, Inc.
2291 Don Chino Roces
Avenue Ext.
Makati City 1231
Philippines
Tel +632 815 8761
Fax +632 816 4997

Singapore

GE Pacific Pte. Ltd.
298 Tiong Bahru Road
#15-01/06 Central Plaza
Singapore 168730
Tel +65 291 8528
Fax +65 277 7688

Taiwan

GE Healthcare Taiwan
11F, 420 Fu Hsin N Road
Taipei, 104
Taiwan
Tel +886 22 2516 5280
Fax +886 22 2516 5290

Thailand

GE Medical Systems
(Thailand) Ltd.
7th Floor
Thanapoom Tower
1550 New Petchburi Road
Makasan, Rattthewi
Bangkok 10400
Thailand
Tel +662 624 8444
Fax +662 624 8431

Vietnam

GE Viet Nam Limited
Metropole Centre
Suite 606-2
56 Ly Thai To Street
Hanoi
Vietnam
Tel +844 934 4254
Fax +844 825 0551

GE Viet Nam Limited
Sun Wah Tower
Suite 1202
115 Nguyen Hue Street
Ho Chi Minh City
Vietnam
Tel +848 812 9399
Fax +848 821 9482

Australia/ New Zealand

GE Healthcare
Australia Pty. Ltd.
Parklands Estate,
Building 4B
21 South Street
Rydalmere NSW 2116
Australia
Tel +61 2 9846 4000
Fax +61 2 9846 4001

Europe

CIS/Baltics

Datex-Ohmeda
Regional Head Office
PO Box 70071
GR-16610 Glyfada -
Athens
Greece
Tel +30 10 9625136-7
Fax +30 10 9623687v

France

GE Healthcare
Information Technologies
& Perinatal Care
11, avenue Morane
Saulnier
78457 Velizy Cedex
France
Tel +33 1 34 49 53 00
Fax +33 1 34 49 53 01

GE Healthcare
Zac de Sans-Souci
1211 Chemin de la Bruyère
69578 Limonest Cedex
France
Tel +33 (0)4 78 66 62 10
Fax +33 (0)4 78 43 26 58

Germany

Datex-Ohmeda GmbH
Munzinger Strasse 3
79111 Freiburg
Germany
Tel +49 761 4543 0
Fax +49 761 4543 233

GE Service Center
T: 0800 434325842273
T: 0800 GEHealthcare

Italy

GE Healthcare
Clinical Systems srl
Via Galeno 36
20126 Milan
Italy
Tel +39 02 26001111
Fax +39 02 26001599

Netherlands

GE Healthcare
De Wel 18
Postbus 22
3870 CA Hoevelaken
Netherlands
Tel 31 33 2541 222
Fax 31 33 2541 223

Spain

GE Healthcare
Avenida de Europa, 22
P.E. La Moraleja
28018 Alcobendas
Madrid
Spain
Tel +34 91 663 2500
Fax +34 91 663 25 01

Sweden

GE Healthcare IT AB
Box 110 70
161 11 Bromma
Sweden
Tel +46 20-389550
Fax +46 8-293530

United Kingdom

Datex-Ohmeda Ltd.
Ohmeda House
71 Great North Road
Hatfield Hertfordshire
AL9 5EN
England
Tel 44 1707 263570
Fax 44 1707 260191

Latin America, Caribbean

GE Healthcare
3350 SW 148th Avenue
Suite 301
Miramar FL 33027-3259
USA
Tel 954 744 5600
Fax 954 744 5613

GE Healthcare
Rua Tomas Carvalhal
711 - Bairro Paraíso
San Paulo, SP 04006-002
Brazil
Tel 55 11 3053 2500/2537

Middle East/ Africa

Datex-Ohmeda
Regional Head Office
PO Box 70071
GR-16610 Glyfada -
Athens
Greece
Tel +30 10 9625136-7
Fax +30 10 9623687

Datex-Ohmeda, Inc., a General Electric Company,
doing business as GE Healthcare.
P.O. Box 7550
Madison, WI 53707-7550
USA

www.gehealthcare.com



© Datex-Ohmeda, Inc. - All rights reserved.

GE and GE Monogram are trademarks of
General Electric Company.

Datex-Ohmeda, Inc., a General Electric Company,
doing business as GE Healthcare.

The addresses listed on this cover are current as of 9/07.

7100 Anes. Ventilator
Technical Reference Manual,
English
1006 0836 000
02 03 B 01 01 02
Printed in USA
©Datex-Ohmeda, Inc.
All rights reserved



0197